

THE
RADIO CONSTRUCTOR

Vol 20 No 9

APRIL 1967

2/6

A DATA PUBLICATION

RADIO • TELEVISION
ELECTRONICS • AUDIO

100/1000 kc/s CRYSTAL STANDARD

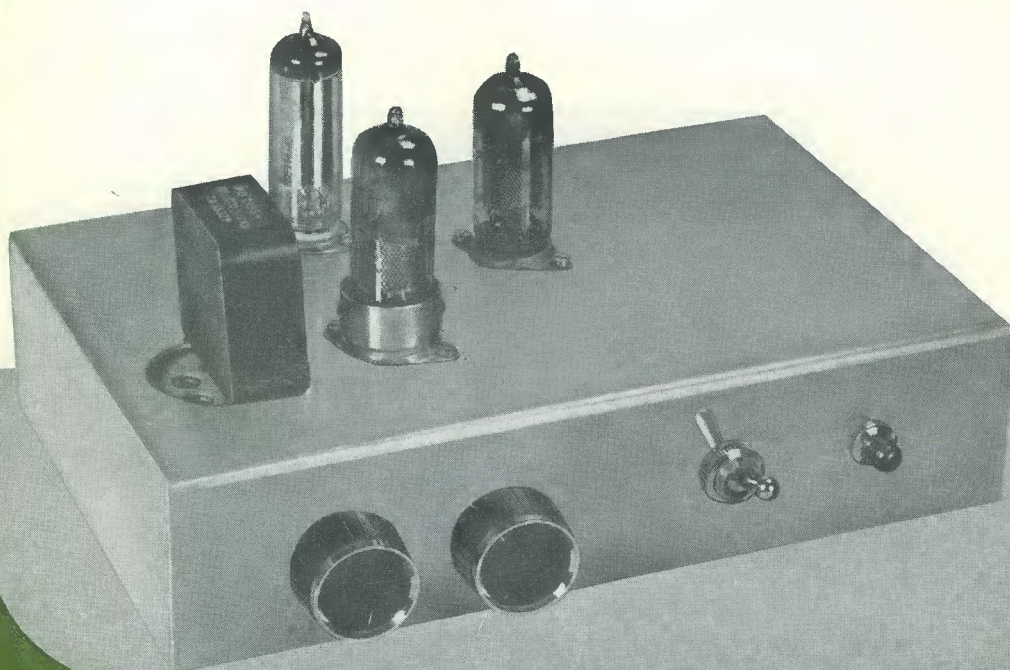

Sound Operated
Switch

Crystal Microphone
Mixer

200 kc/s
Front End

Simple
Voltmeter

Scottish Insurance Corporation Ltd

66-67 CORNHILL · LONDON · EC3



*TELEVISION
SETS,
RECEIVERS
AND
TRANSMITTERS*

Television Sets, Receivers and Short Wave Transmitters are expensive to acquire and you no doubt highly prize your installation. Apart from the value of your Set, you might be held responsible should injury be caused by a fault in the Set, or injury or damage by your Aerial collapsing.

A "Scottish" special policy for Television Sets, Receivers and Short Wave Transmitters provides the following cover:

- (a) Loss or damage to installation (including in the case of Television Sets the Cathode Ray Tube) by Fire, Explosion, Lightning, Theft or Accidental External Means at any private dwelling-house.
- (b) (i) Legal Liability for bodily injury to Third Parties or damage to their property arising out of the breakage or collapse of the Aerial Fittings or Mast, or through any defect in the Set. Indemnity £10,000 any one accident.
- (ii) Damage to your property or that of your landlord arising out of the breakage or collapse of the Aerial Fittings or Mast, but not exceeding £500.

The cost of Cover (a) is 5/- a year for Sets worth £50 or less, and for Sets valued at more than £50 the cost is in proportion. Cover (b) (i) and (ii) costs only 2/6 a year if taken with Cover (a), or 5/- if taken alone.

Why not BE PRUDENT AND INSURE your installation—it is well worth while AT THE VERY LOW COST INVOLVED. If you write to the Corporation's Office a proposal will be submitted for completion.

Write for full details, quoting reference 5304, to:—

THE MANAGER
SCOTTISH INSURANCE CORPORATION LTD.,
66-67 CORNHILL, LONDON E.C.3

T.R.S. BARGAINS IN KITS, COMPONENTS AND EQUIPMENT

STEREO AMPLIFIER SYSTEMS

TRS MULLARD 10-10

- 10 + 10 watts output
 - For 3 and 15 ohms speakers.
 - Complete with valves
- £17.10.0**

(Carr. & Pkg. 10/-).
Ready wired and tested, 50/- extra.
Ready built version only available at present.

This newest design from Mullard comprises integrated stereo pre-amp and amplifier with 10 watts output per channel. Kitted by TRS to exact specification with top quality components. Ultra-linear class B output with transformers tapped for 3 and 15 ohms; bass, treble, volume and balance controls; switching for mono/stereo, speaker phasing, and P.U. and Radio; input sensitivity—210mV, per section; H.T. and L.T. outlets for tuner. Pre-amp section metal shrouded With knobs, plugs, escutcheon panel and pilot light indicator. Size 11 x 10 $\frac{1}{2}$ x 4 $\frac{1}{2}$ in. Ideal for use with Garrard Units offered below.

SINCLAIR Z.12.

Very good stereo is obtainable with two of these units which can be used for 3, 5, 8 or 15 ohms speakers. Instructions enable you to use matched control circuits with all types of inputs for which we supply the necessary parts. Z.12 Amplifier as advertised in this journal, each, **£9.19.6**
SINCLAIR STEREO 25 De luxe pre-amp, ready built and ideal for two Z.12 **£9.19.6**
P.Z.3 Mains Power Unit, **79/6**

PEAK SOUND SA 8-8.

14 transistor integrated stereo pre-amp and amplifier giving 17 watts output into two 5 ohm speakers. A fascinating kit to build, crammed with original features including "Shadow Template" and supply of Cir-kit. Complete down to wire and solder. **£12.19.6**
Mains power supply unit for SA.8-8, **75/-**

GARRARD UNITS AND PLINTHS

I.M. 3000. Autochanger with 9TA stereo cartridge. **8 gns.**

AT60 AUTOCHANGER DE-LUXE. With Die cast turntable, less cartridge. **91/2 gns.**

SP.25 DE-LUXE. Die-cast turntable. Single playing unit. Less cartridge. Carr. and packing on any of above, 7/6. **91/2 gns.**

GARRARD PLINTH.

Suitable for use with any of the units here. Teak with plastic cover (Carr. and packing, 5/-). **£3.15.0**

GARRARD CART-RIDGES.

All types available. Post free. From Mono at 15/- to Stereo from **25/-**

We stock Sapphire and Diamond Stylis for most pick-ups at attractive prices.

EXCLUSIVE TRS OFFER PROFESSIONAL TAPE IN UNIQUE LIBRARY WALLETS

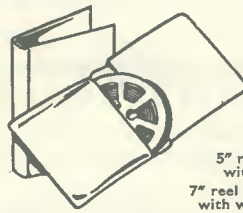

With each reel of this tape by an internationally famous manufacturer we give you a beautifully made wallet strongly made in simulated leather with space for a reel of tape each side. This is professional quality full frequency tape with metalised leader/stop foils. These library wallets solve once and for all the problems of storing tapes efficiently and tidily.

5" reel, 900' with wallet **12/6** 5 $\frac{1}{2}$ " reel, 1200' with wallet **17/6**
7" reel 1800' with wallet **22/6** p. & p. 1/6 per reel



RADIO COMPONENT SPECIALISTS

70 Brigstock Rd, Thornton Heath, Sy

Telephone THO 2188. Hours 9.0 a.m.—6.0 p.m. daily, 1.0 p.m. Wed.

Established 1946

MAKE A NOTE OF THESE

TRS Decoder, 6 transistor model £4.19.6. Built and tested £5.5.0: FMT41 6 transistor FM Tuner, built £8.10.0: TRS 6 valve AM/FM Tuner kit complete 11 gns:

FOR LATEST COMPREHENSIVE LISTS (APRIL ISSUE) SHOWING FULL RANGES OF OUR VERY LARGE STOCKS AT BARGAIN PRICES.
SEND 3d

FREE TO AMBITIOUS ENGINEERS

—THE LATEST EDITION OF ENGINEERING OPPORTUNITIES

Have you sent for your copy?

ENGINEERING OPPORTUNITIES is a highly informative 132-page guide to the best paid engineering posts. It tells you how you can quickly prepare at home for a recognised engineering qualification and outlines a wonderful range of modern Home Study Courses in all branches of Engineering. This unique book also gives full details of the Practical Radio & Electronic Courses, administered by our Specialist Electronics Training Division—explains the benefits of our Appointments Dept. and shows you how to qualify for five years promotion in one year.

SATISFACTION OR REFUND OF FEE

Whatever your age or experience you cannot afford to miss reading this famous book. If you are earning less than £30 a week send for your copy of "ENGINEERING OPPORTUNITIES" today—FREE.

WHICH IS YOUR PET SUBJECT

- RADIO
- TELEVISION
- ELECTRONICS
- ELECTRICAL
- MECHANICAL
- CIVIL
- PRODUCTION
- AUTOMOBILE
- AERONAUTICAL
- PLASTICS
- BUILDING
- DRAUGHTSMANSHIP
- B.SC.
- CITY & GUILDS
- GENERAL CERTIFICATE OF EDUCATION
- ETC., ETC.

PRACTICAL EQUIPMENT

Basic Practice and Theoretical Courses for beginners in Radio T.V. Electronics Etc. A.M.I.E.R.E. City & Guilds Radio Amateur's Exam. R.T.E.B. Certificate. P.M.G. Certificate. Practical Radio, Radio & Television Servicing Practical Electronics Electronics Engineering Automation

INCLUDING TOOLS!

The specialist Electronics Division of B.I.E.T.

NOW offers you a real laboratory training at home with practical equipment—

Ask for details.



POST COUPON NOW!

- Please send me your FREE 132-page "ENGINEERING OPPORTUNITIES"
- (Write if you prefer not to cut page)

■ NAME

■ ADDRESS

■

■

■ SUBJECT OR EXAM THAT INTERESTS ME 409B

BRITISH INSTITUTE OF ENGINEERING TECHNOLOGY

(Dept. 409B), Aldermaston Court, Aldermaston, Berkshire

THE B.I.E.T. IS THE LEADING INSTITUTE OF ITS KIND IN THE WORLD

HI-FI AMPLIFIERS ~~~~~ TUNERS ~~~~~ RECORD PLAYERS

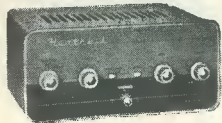

3+3W
STEREO
AMP.
S-33H

10W POWER AMPLIFIER. Model MA-12. 10W output, wide freq. range, low distortion. For use with control unit. Kit £12.18.0 Assembled £16.18.0



10W
POWER
AMP.
MA-12

DE LUXE STEREO AMPLIFIER. Model S-33H. De luxe version of the S-33 with two-tone grey perspex panel, and higher sensitivity necessary to accept the Decca Deram pick-up. Kit £15.17.6 Assembled £21.7.6

HI-FI STEREO AMPLIFIER. Model S-99. 9 + 9W output. Ganged controls. Stereo/Mono gram., radio and tape inputs. Push-button selection. Printed circuit construction. Kit £28.9.6 Assembled £38.9.6

TRANSISTOR PA/GUITAR AMPLIFIER, PA-2. 20W amplifier. Four inputs. Variable tremolo. New Low Price Kit £39.19.0 Assembled £54.10.0

50W VALVE PA/GUITAR AMP., PA-1. Kit £54.15.0 Assembled £74.0.0



GARRARD
PLAYER
AT-60

TRANSISTOR MIXER. Model TM-1. A must for the tape enthusiast. Four channels. Battery operated. Similar styling to Model AA-22U Amplifier. With cabinet. Kit £11.16.6 Assembled £16.17.6

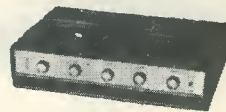

20+20W
STEREO
AMP.
AA-22U

20+20W TRANSISTOR STEREO AMPLIFIER. Model AA-22U. Outstanding performance and appearance. Kit £39.10.0 (less cabinet). Assembled £57.10.0 Attractive walnut veneered cabinet £2.5.0 extra.

GARRARD AUTO/RECORD PLAYER. Model AT-60. less cartridge £14.12.10 With Decca Deram pick-up £19.7.4 incl. P.T. Many other Garrard models available, ask for Lists.

HI-FI MONO AMPLIFIER. Model MA-5. A general purpose 5W Amplifier, with inputs for Gram., Radio. Attractive modern styling. Kit £11.9.6 Assembled £15.15.0



ENJOY YOURSELF AND SAVE MONEY

Finished models provide years of superlative performances

INSTRUMENTS

3" LOW-PRICED SERVICE OSCILLOSCOPE. Model OS-2. Compact size 5" x 7 1/2" x 12" deep. Wt. only 9 1/2 lb. "Y" bandwidth 2 c/s-3 Mc/s ± 3dB. Sensitivity 100mV/cm. T/B 20 c/s-200 kc/s in four ranges, fitted mu-metal CRT Shield. Modern functional styling.

Kit £23.18.0 Assembled £31.18.0

5" GEN-PURPOSE OSCILLOSCOPE. Model 10-12U. An outstanding model with professional specification and styling. "Y" bandwidth 3 c/s-4.5 Mc/s ± 3dB. T/B 10 c/s-500 kc/s.

Kit £35.17.6 Assembled £45.15.0

DE LUXE LARGE-SCALE VALVE VOLTMETER. Model IM-13U. Circuit and specification based on the well-known model V-7A but with many worth-while refinements. 6" Ernest Turner meter. Unique gimbal bracket allows operation of instrument in many positions. Modern styling. Kit £18.18.0 Assembled £26.18.0

AUDIO SIGNAL GENERATOR. Model AG-9U. 10 c/s to 100 kc/s, switch selected. Distortion less than 0.1%, 10V sine wave output metered in volts and dB's.

Kit £23.15.0 Assembled £31.15.0

VALVE VOLTMETER. Model V-7A. 7 voltage ranges d.c. volts to 1,500. A.c. to 1,500 r.m.s. and 4,000 peak to peak. Resistance 0.1Ω to 1,000MΩ with internal battery. D.c. input resistance 11MΩ. dB measurement, has centre-zero scale. Complete with test prods, leads and standardising battery.

Kit £13.18.6 Assembled £19.18.6

MULTIMETER. Model MM-1U. Ranges 0-1.5V to 1,500V a.c. and d.c.; 150μA to 15A d.c.; 0.2Ω to 20MΩ. 4 1/2" 50μA meter. Kit £12.18.0 Assembled £18.11.6

R.F. SIGNAL GENERATOR. Model RF-1U. Up to 100 Mc/s fundamental and 200 Mc/s on harmonics. Up to 100mV output.

Kit £13.18.0 Assembled £20.8.0

SINE/SQUARE GENERATOR. Model IG-82U. Freq. range 20 c/s-1 Mc/s in 5 bands less than 0.5% sine wave dist. less than 0.15μ sec. sq. wave rise time.

Kit £25.15.0 Assembled £37.15.0

TRANSISTOR POWER SUPPLY. Model IP-20U. Up to 50V, 1.5A output. Ideal for Laboratory use. Compact size.

Kit £35.8.0 Assembled £47.8.0



OS-2



IM-13U



V-7A



RF-1U

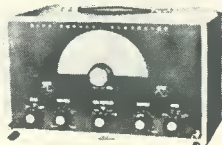

IG-82U

MO Prices quoted
Retail Prices in
general 5% extra

Complete your motoring pleasure with this outstanding CAR RADIO, Model CR-1



Will give you superb LW and MW entertainment wherever you drive. Tastefully styled to harmonise with any car colour scheme. Available for your convenience in two separate parts, RF Amp. Kit £1.13.6 incl. P.T. IF/AF Amp. Kit £1.13.6.

Total Price Kit (excl. Loudspeaker) £12.17.0 incl. P.T.
8" x 5" Loudspeaker £1.16.1 incl. P.T.

TRANSISTOR RADIOS

"OXFORD" LUXURY PORTABLE. Model UXR-2. Specially designed for use as a domestic, car or personal portable receiver. Many features, including solid leather case. Kit £14.18.0 incl. P.T.



UXR-2

TRANSISTOR PORTABLE. Model UXR-1. Pre-aligned I.F. transformers, printed circuit. Covers L.W. and M.W. Has 7" x 4" loudspeaker. Real hide case.



UXR-1

Kit £12.11.0 incl. P.T.
JUNIOR EXPERIMENTAL WORKSHOP Model EW-1. More than a toy! Will make over 20 exciting electronic devices, incl: Radios, Burglar Alarms, etc 72 page Manual. The ideal present! Kit £7.13.6 incl. P.T.

STEREO TRANSISTOR FM TUNER.

(Mono version also available)
14 transistor, 5 diode circuit. Tuning range 88-108 Mc/s. Designed to match the AA-22U Amplifier. Available in separate units, can be built for a total price.

Kit (Stereo) £24.18.0 incl. P.T.
Kit (Mono) £20.19.0 incl. P.T.
Cabinet extra £2.5.0.



FM Tuner

WELCOME TO OUR LONDON HEATHKIT CENTRE
233 Tottenham Court Road, W.1

We open MONDAY - FRIDAY 9 a.m. - 5.30 p.m.
SATURDAY ... 9 a.m. - 1.0 p.m.
Telephone No: 01-636.7349

WHEN YOU ARE IN TOWN, WE HOPE YOU WILL VISIT US THERE

TAPE AMPLIFIERS ~~~~~ TAPE DECKS ~~~~~ CONTROL UNITS

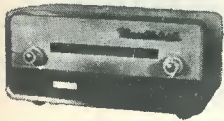

**FM TUNER
FM-4U**



**STEREO
DECODER
SD-1**

HI-FI FM TUNER. Model FM-4U. Available in two units. R.F. tuning unit (£2.15.0 incl. P.T.) with I.F. output of 10.7 Mc/s, and I.F. amplifier unit, with power supply and valves (£13.13.0). May be used free standing or in a cabinet. Total Kit **£16.8.0** (Multiplex adapter available, as extra.)

HI-FI AM/FM TUNER. Model AFM-1. Available in two units which, for your convenience, are sold separately. Tuning heart (AFM-T1—£4.13.6 incl. P.T.) and I.F. amplifier (AFM-A1—£22.11.6). Printed circuit board, 8 valves. Covers L.W., M.W., S.W., and F.M. Built-in power supply. Total Kit **£27.5.0** (Multiplex adapter available, as extra.)

STEREO DECODER Model SD-1. Converts FM Mono receivers to stereo at low-cost. Styled to match Heathkit models FM-4U and AFM-1 Tuners. Kit **£8.10.0** Assembled **£12.5.0**

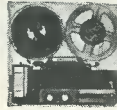

**TRUVOX
DECK**



**AM/FM
TUNER**

MAGNAVOX "363" TAPE DECK. The finest buy in its price range. Operating speeds: 1 $\frac{1}{2}$ ", 3 $\frac{1}{4}$ " and 7 $\frac{1}{2}$ " p.s. Two tracks, "wow" and "flutter" not greater than 0.15% at 7 $\frac{1}{2}$ " p.s. **£13.10.0**

TRUVOX D-93 TAPE DECKS. High quality stereo/mono tape decks. D106, $\frac{1}{2}$ track, **£36.15.0** D108, $\frac{1}{2}$ track, **£36.15.0**

TAPE RECORDING/PLAYBACK AMPLIFIER
Mono Model TA-IM kit **£19.18.0** Assembled **£28.18.0**
Stereo Model TA-IM kit **£25.10.0** Assembled **£35.18.0**

HI-FI CABINETS. A wide range available for example: Malvern Kit **£18.1.0** incl. P.T.

MONO CONTROL UNIT. Model UMC-1. Designed to work with the MA-12 or similar amplifier requiring 0.25V or less for full output. 5 inputs. Baxandall type controls. Kit **£9.2.6** Assembled **£14.2.6**

Build Britain's Best Electronic Kits

No special Kit-building skills or Electronic Knowledge required



SSU-1

SPEAKER SYSTEMS

HI-FI SPEAKER SYSTEM. Model SSU-1. Ducted-port bass reflex cabinet "in the white". Two speakers. Vertical or horizontal models with legs, Kit **£12.12.0**, without legs, Kit **£11.17.6** incl. P.T.

THE BERKELEY Slim-line SPEAKER SYSTEM, fully finished walnut veneered cabinet for faster construction. Special 12" bass unit and 4" mid/high frequency unit. Range 30-17,000 c/s. Size 26" x 17" x only 7 $\frac{1}{2}$ " deep. Modern attractive styling. Excellent value.

Kit **£19.10.0** Assembled **£24.0.0**

COTSWOLD SPEAKER SYSTEMS. Outstanding performance for price.

MFS: Size 36" x 16 $\frac{1}{2}$ " x 14" deep.

Kit **£25.12.0** Assembled **£33.17.0**

STANDARD: Size 26" x 23" x 14 $\frac{1}{2}$ " deep.

Kit **£25.12.0** Assembled **£33.17.0**



Berkeley

'AVON' Low-cost Mini Speaker System ... with Hi-Fi performance

6 $\frac{1}{2}$ " Bass speaker, 3 $\frac{1}{2}$ " enclosed treble unit, Inductor-capacitor cross-over network. Kit **£4.18.0** incl. P.T. Strongly constructed, fully-finished walnut veneered cabinet Kit **£8.18.0**. Compact size gives wide 50-19000 c/s range.

TOTAL PRICE:

Kit **£13.16.0** incl. P.T.

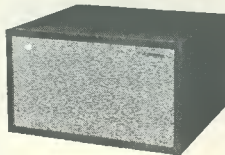

"AMATEUR" EQUIPMENT

THE "MOHICAN" GENERAL COVERAGE RECEIVER. Model GC-1U. With 4 piezo-electric transmitters, variable tuned B.F.O. and Zener diode stabiliser, this is an excellent fully transistorised general purpose receiver for Amateur and Short wave listeners. Printed circuits, telescopic aerial, tuning meter and large slide-rule dial. Kit **£37.17.6** Assembled **£45.17.6**

AMATEUR BANDS RECEIVER. Model RA-1. To cover all the Amateur Bands from 160-10 metres. Many special features, including: half-lattice crystal filter; 8 valves; signal strength "S" meter; tuned R.F. Amp. stage. Kit **£39.6.6** Assembled **£52.10.0**

160-10M TRANSMITTER. Model DX-100U. Careful design has achieved high performance and stability. Completely self-contained. Kit **£81.10.0** Assembled **£106.15.0**

COMMUNICATIONS TYPE RECEIVER. Model RG-1. A high performance, low cost receiver for the discriminating listener. Frequency coverage: 600 kc/s-1.5 Mc/s and 1.7 Mc/s-32 Mc/s. Kit **£39.16.0** Assembled **£53.0.0**

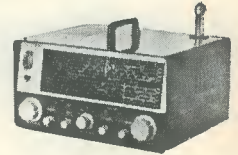

GC-1U

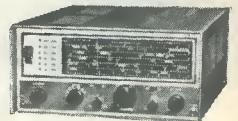

RG-1

Low-cost 3 + 3W Transistor Stereo Amplifier, TS-23



Incorporating all the essential features for good quality sound reproduction from record, radio and other sources. 16 Transistor, 4 diode circuit. Good frequency response, 6 position selector switch. Modern slim line styling.

Kit (less cabinet) **£17.15.0**

Kit (with handsome finished cabinet) **£18.19.0**



Send for this
Catalogue ...

... it's FREE!

28 pages packed with Britain's largest selection of electronic Kits. Mail coupon or write:

**DAYSTROM LTD., Dept. RC-4
GLOUCESTER. Tel. 20217.**

To **DAYSTROM LTD., GLOUCESTER**

Please send me **FREE BRITISH CATALOGUE**

Please send me details of models

Please send a
Catalogue to my
friend

Name _____

Address _____

NAME _____

ADDRESS _____

RC-4

RC-4

THE WORLD'S SMALLEST RADIO

Measures only $1\frac{4}{5}$ " x $1\frac{3}{10}$ " x $\frac{1}{2}$ "

Check it for yourself!

AND THE PERFORMANCE TOO

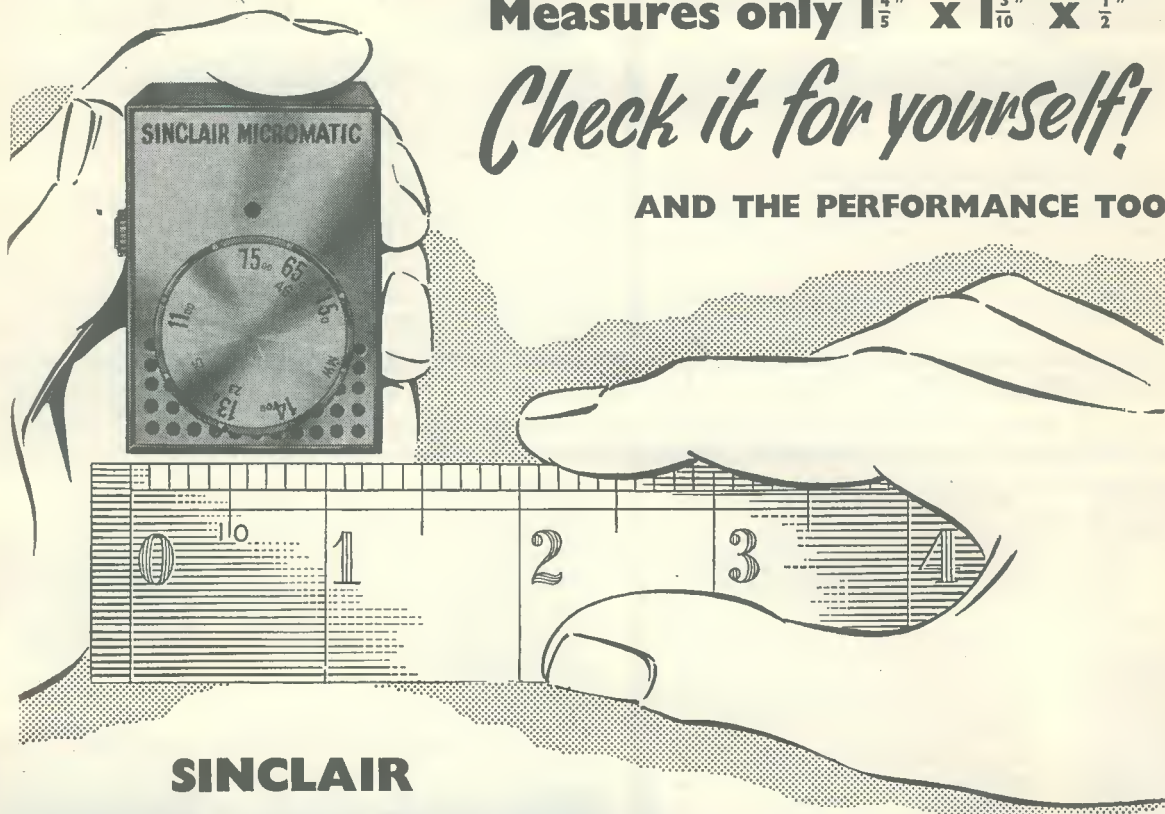

SINCLAIR MICROMATIC Six stage transistor receiver

- ★ CALIBRATED DIAL
- ★ NEW CIRCUITRY
- ★ BANDSPREAD
- ★ AMAZING POWER AND RANGE
- ★ 5-YEAR GUARANTEE

These are the facts—the Sinclair Micromatic is so small that its design brings it into the realm of micro-electronics. Its performance and reliability are so good that it assures superb reception virtually anywhere. Its elegant styling inside and out make this a truly professional receiver, yet building the Micromatic is so simple that anyone can tackle it with complete confidence. Check these facts for yourself, and when you use your Micromatic, you will find it the radio thrill of a lifetime.

TECHNICAL DESCRIPTION

The Sinclair Micromatic is housed in a neat plastic case with aluminium front panel and spun aluminium calibrated tuning dial.

Special Sinclair transistors are used in a six-stage circuit of exceptional power and sensitivity—two stages of powerful R.F. amplification; double diode detector; a high gain three stage audio amplifier. A G.C. contracts fading from distant stations. The set is powered by two Mallory ZM.312 Cells readily obtainable from radio shops. Boots Chemists, etc., for 1/7 each. Plugging in the earpiece switches the set on. Complete kit in pack with instructions and solder.

FULL SERVICE FACILITIES AVAILABLE

Ready built and tested with earpiece **79/6**

IN THE UNIQUE "SEE-FOR-YOURSELF" PACK **59/6**



sinclair

SINCLAIR RADIONICS LIMITED
22 NEWMARKET ROAD, CAMBRIDGE. Telephone OCA3-52731

SINCLAIR Z12

INTEGRATED 12 WATT
AMPLIFIER AND PRE-AMP

A MASTER OF POWER,
COMPACTNESS AND
VERSATILITY

For size alone, the Z.12 marks an important advance in quality design, for its amazing compactness opens up exciting new vistas in amplifier housing and application. Combined with this are fantastic power and superb quality which can provide an effortless output of 12 watts R.M.S. continuous sine wave from the unique eight transistor circuit used. Basically intended as the heart of any good mono or stereo hi-fi system, the size and efficiency of this Sinclair unit make it equally useful for a car radio (with the Micro-6 for example), a high quality radio with the Micro FM, in a guitar, P.A. or intercom system, etc. Other applications are certain to suggest themselves to constructors. The manual included with the Z.12 details mono and stereo tone and volume control circuits by which inputs can be matched (and switched in) to the pre-amp. The size, performance and price of the Z.12 all favour the constructor seeking the finest in transistorised audio reproduction—it is in fact today's finest buy in top grade high fidelity.

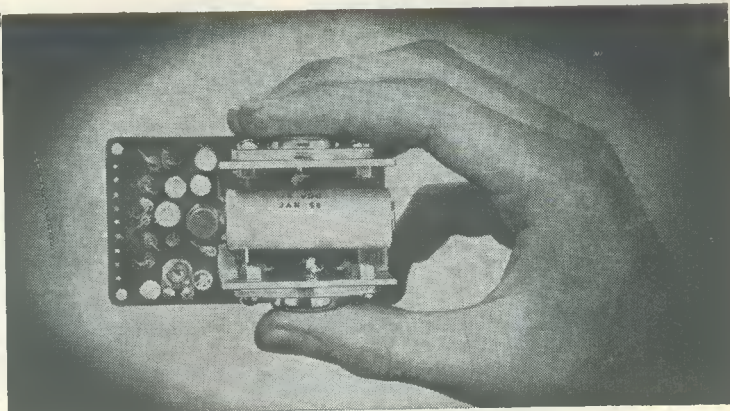

12 WATTS R.M.S. OUTPUT CONTINUOUS SINE WAVE (24 W. PEAK)
15 WATTS R.M.S. MUSIC POWER (30 WATTS PEAK)

- ★ Ultra-linear class B output and generous neg. feedback.
- ★ Response—15 to 50,000 c/s ± 1 dB.
- ★ Output suitable for 3, 7.5 and 15 ohms loads. Two 3 ohm speakers may be used in parallel.
- ★ Input—2mV into 2K ohms.
- ★ Signal to noise ratio—better than 60dB.

Built, tested
and
guaranteed.

89'6

SINCLAIR MICRO FM

Combined FM Tuner Receiver

- ★ Use it as a Tuner
- ★ Use it as a Pocket F.M. Receiver
- ★ Outstanding Quality
- ★ Remarkable Circuitry using low I.F., Pulse-counting Discriminator & A.F.C.

Less than 3" x 1½" x ½" and professional in every way, 7 transistor FM using pulse counting discriminator for superb audio quality. Low I.F. makes alignment unnecessary. Tunes 88-108 Mc/s. The telescopic aerial suffices for good reception in all but poorest areas. Signal to noise ratio—30dB at 30 microvolts. Takes standard 9V battery. One outlet feeds to amplifier or recorder, the other allows set to be used as a pocket portable. Brushed and polished aluminium front, spun aluminium dial. A fascinating set to build.



Complete kit inc. aerial, case, earpiece and instructions.

£5.19.6

GUARANTEE

If you are not completely satisfied when you receive your purchase from us, your money will be refunded at once in full and without question.

sinclair

SINCLAIR RADIONICS LIMITED
22 NEWMARKET ROAD, CAMBRIDGE



SINCLAIR STEREO 25

De-Luxe Pre-amp & Control Unit for Z.12 or other good stereo system

Designed specially to obtain the very finest results used with two Sinclair Z.12's for stereo. The best quality components, individually tested before acceptance, are used in its construction, whilst the overall appearance of this compact de-luxe pre-amp and control unit reflects the professional elegance which characterises all Sinclair designs. The front panel is in solid brushed and polished aluminium with beautifully styled solid aluminium knobs. Mounting

is simple, and the PZ.3 will comfortably power the Stereo 25 together with two Z.12's. When fitted, the Sinclair 25 will grace any type of hi-fi furniture. Frequency response 25 c/s to 30 kc/s ± 1 dB connected to two Z.12's. Sensitivity Mic. 2mV into 50k Ω ; P.U. —3mV into 50k Ω ; Radio —20mV into 4.7k Ω . Equalisation correct to within ± 1 dB on R1AA curve from 50 to 20,000 c/s. Size 6½" x 2½" x 2½" plus knobs.

BUILT, TESTED
AND
GUARANTEED

£9.19.6

Sinclair PZ.3 Transistorised mains power unit. Will power up to two Z.12's and Stereo 25 with ease.

79'6

SINCLAIR RADIONICS LTD., 22 NEWMARKET ROAD, CAMBRIDGE

Please send

NAME

ADDRESS

for which I enclose cash/cheque/money order
value £.....s.....d.

RC4

BOUND VOLUME No. 19 of "The Radio Constructor" FOR YOUR LIBRARY



Comprising
780 pages
plus index

Volume 19 August 1965 to July 1966

PRICE 30/- Postage 4/6

Special discount of 10/- for regular readers

Where the 12 monthly issues making up the volume are returned, the price is only 20/- plus 4/6 postage

Available only from:—

Data Publications Ltd.
57 Maida Vale London W9

FOULSHAM-SAMS NEW BOOKS

ABC's OF ELECTRONIC TEST PROBES	20s net
ELECTRONIC CABLE HANDBOOK	30s net
ABC's OF CAPACITORS	20s net
COMPUTERS SELF-TAUGHT THROUGH EXPERIMENTS	30s net
HOW TO REPAIR SMALL APPLIANCES	20s net
BUILDING YOUR AMATEUR RADIO NOVICE STATION	28s net
CAR RADIO SERVICING MADE EASY	24s net
DIRECT READOUT METERS	26s net
APPLICATIONS HANDBOOK FOR ELECTRICAL CONNECTORS	25s net
T.V. SYNC AND DEFLECTION CIRCUITS	25s net
MODERN DICTIONARY OF ELECTRONICS	50s net
TRANSISTOR TECHNOLOGY	30s net
T.V. VIDEO AND SOUND CIRCUITS	25s net
2-WAY MOBILE RADIO HANDBOOK	30s net
UNDERSTANDING AMPLITUDE MODULATION	25s net

Write for complete Catalogue:
W. FOULSHAM & CO. LTD.
Yeovil Road, Slough, Bucks.

MAKE THIS MULTI-PURPOSE AUDIO SWITCH

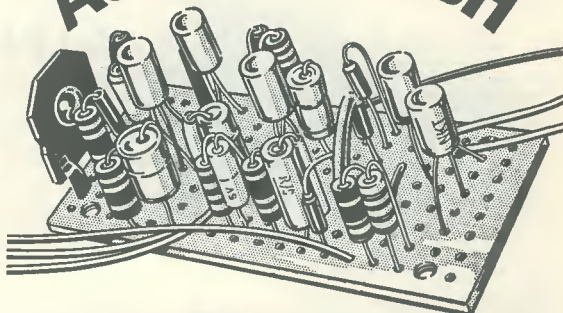

... from full instructions in the May PRACTICAL WIRELESS. Assembled on Veroboard, this 5 transistor unit can switch on or off a radio, TV, lighting, heating, tape recorder, dictation machine, etc., up to a range of 30ft. by audible means.
Other Constructional Features: Converter for 70 cm. Band; 3-Band Mains Receiver; Simple Analogue Computer.

**PRACTICAL
WIRELESS**

**MAY ISSUE
OUT
7th APRIL
2'6**

TRANSISTORISED SIGNAL GENERATOR

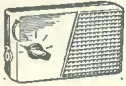

Size 5½" x 3½" x 1½". For IF and RF alignment and AF output, 700 c/s frequency coverage 460 Kc/s to 2 Mc/s in switched frequencies. Ideal for alignment to our Elegant Seven and Musette. Built and tested. 39/6. P. & P. 3/6.

TRANSISTORISED 1½ WATT AMPLIFIER

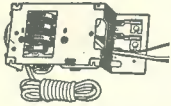

Comprising 2AC 128, 20C 75 and 2 AA129 separate bass and treble volume controls. Complete with Power Supply AC mains 240V size 7½" x 3½" x 2". Price 50/- plus 2/6 P. & P.

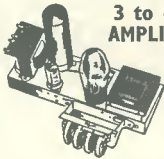

3 to 4 WATT AMPLIFIER KIT

3-4 watt Amplifier built and tested. Chassis size 7" x 3½" x 1".

Separate bass, treble and volume control. Double wound mains transformer, metal rectifier and output transformer for 3 ohms speaker. Valves ECC81 and 6V6. £2.5.0 plus 5/6 p.p. The above in Kit Form, 34/6 plus 5/6p.p.

8-watt 4-valve PUSH-PULL AMPLIFIER & METAL RECTIFIER

Size: 9" x 6" x 1½". A.C. Mains, 200-250V 4 valves. For use with Std. or L.P. records, musical instruments, all makes of pick-ups and mikes. Output 8 watts at 5 per cent of total distortion. Separate bass and treble lift control. Two inputs, with controls for gram, and mike. Output transformer tapped for 3 and 15 ohm speech coils. Built and tested, £4.4.0. P. & P. 11/-, 8" x 5" speaker to suit price 14/6 plus 1/6 P. & P. Crystal mike to suit 12/6 plus 1/6 P. & P.

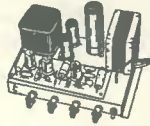

"MUSETTE" 6-Transistor Superhet Portable Radio

★ 2½" Speaker. ★ 6 Transistors Superhet Output 200mW. ★ Plastic Cabinet in red, size 4½" x 3" x 1½" and gold speaker louvre. ★ Horizontal Tuning Scale. ★ Ferrite Rod Internal Aerial. ★ IF 460 kc/s. ★ All components Ferrite Rod and Tuning Assembly mount on printed board. ★ Operated from PP3 Battery. ★ Fully comprehensive instructions and point-to-point wiring diagram. ★ Printed Circuit Board. ★ Tunable over medium and long waveband. ★ Car aerial and earpiece socket.

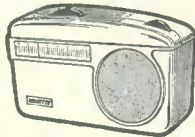

Price 39/6d inc. carrying strap. Circuit Diagram 2/6 -free with parts. P. & P. 3/6

ELEGANT SEVEN Mk. IIA

SPECIAL OFFER, 7" x 4" P.M. Speaker at no extra charge. Power supply kit to purchasers of "Elegant Seven" parts, incorporating mains transformer, rectifier and smoothing condenser, A.C. mains 200/250 volts. Output 9V 100mA. 7/6 extra.

Buy yourself an easy to build 7 transistor radio and save at least £10.0.0. Now you can build this superb 7 transistor superhet radio for under £4.10.0. No one else can offer such a fantastic radio with so many de luxe star features.

★ De luxe grey wooden cabinet size 12½" x 8½" x 3½". ★ Horizontal easy to read tuning scale printed grey with black letters, size 11½" x 2". ★ High "Q" ferrite rod aerial. ★ I.F. neutralisation on each separate stage. ★ D.C. coupled push pull output stage with separate A.C. negative feedback. ★ Room filling output 350mW. ★ Ready etched and drilled printed circuit board back printed for foolproof construction. ★ Fully comprehensive instructions and point to point wiring diagrams. ★ Car aerial socket. ★ Fully tunable over medium and long wave, 168-535 metres and 1250-2000 metres. ★ All components, ferrite rod and tuning assembly mount on printed board. ★ Full after sales service. ★ Parts list and circuit diagram 2/6, free with parts.

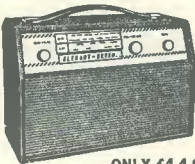

ONLY £4.4.0
Plus 7/6 Post & Packing

RADIO & TV COMPONENTS (ACTON) LTD.

21G High St., Acton, London, W.3

Shop Hours 9 a.m.-6 p.m. Early Closing Wednesday
Goods not despatched outside U.K. Terms C.W.O.
All enquiries Stamped Addressed Envelope.

Also at 323 Edgware Road, London, W.2.
Personal shoppers only. Early closing Thursday
All orders by post to our Acton address



IMPROVE YOUR HOME RECEPTION

UNBEATABLE VALUE FOR YOU,
AS A READER OF
THE RADIO CONSTRUCTOR

THE NEW
TOLTEC
HAIR DRYER

52'6

Add 4/6 for postage



SPECIFICATION

Moulded in beautiful symmetrical pastel blue impact resisting thermoplastic casing.

Quiet in operation.

Hot or cold air.

No radio or T.V. Interference—meets British standard specification.

Fitted with safety cut-out.

12 months & money refund guarantee.

230-250 volts A.C. only.

Value 80/9 in the shops

Send the coupon below with the sum of only 52/6 (plus 4/6d to cover postage, packing and insurance, unless you are collecting personally) to:—

THE TOLTEC ELECTRONIC & TRADING CO. LTD.,

HATTON HOUSE, HURST GREEN, SUSSEX

If you are not delighted with your purchase, its price will be refunded if the appliance is carefully replaced in its mail-order pack and returned safely within seven days.

GET YOUR APPLICATION AWAY TODAY

THE RADIO CONSTRUCTOR

Toltec Hair Dryer Offer

VOUCHER WORTH 28'3

THINKS
(OLD STYLE)



THINKS
(NEW STYLE)
MUCH EASIER!



Thinking is all very well in its place, but one should not over do it! Reserve the brain power for the circuits and leave to us the worry of supplying the parts. For you are certain to find all you require among the 6,000 items listed in our catalogue, and once we receive your order it is dealt with promptly.

The catalogue costs 7/6, plus 1/6 post & packing, and every copy contains 5 vouchers, each worth one shilling when used as directed. Every catalogue includes an easy-to-complete order form and an envelope for its speedy return—little things which all help to make life easier. Moreover you will receive from time to time new supplements to keep your catalogue bang up to date.

Have a go!

Fill in the coupon and send your P.O. or cheque for 9/- today!

Please write your Name and Address in block capitals

Name

Address

Home Radio Ltd., Dept. RC, 187 London Rd., Mitcham, CR4 2YQ



Vol. 20, No. 9

Published Monthly (1st of month)

Editorial and Advertising Offices

57 MAIDA VALE LONDON W9

Telephone

CUNningham 6141

Telegrams

Databux, London

21st Year of Publication

© Data Publications Ltd., 1967. Contents may only be reproduced after obtaining prior permission from the Editor. Short abstracts or references are allowable provided acknowledgement of source is given.

Annual Subscription 36s. (U.S.A. and Canada \$5) including postage. Remittances should be made payable to "Data Publications Ltd". Overseas readers please pay by cheque or International Money Order.

Queries. We regret that we are unable to answer queries other than those arising from articles appearing in this magazine nor can we advise on modifications to equipment described. Queries should be submitted in writing and accompanied by a stamped addressed envelope for reply.

Correspondence should be addressed to the Editor, Advertising Manager, Subscription Manager or the Publishers as appropriate.

Opinions expressed by contributors are not necessarily those of the Editor or proprietors.

Production.—Letterpress/contact litho.

Published in Great Britain by the Proprietors and Publishers
Data Publications Ltd. 57 Maida Vale London W9
Printed by A. Quick & Co. (Printers) Ltd.
Clacton-on-Sea England

Audio Frequency Inductance Capacitance Meter, <i>by Sir Douglas Hall, K.C.M.G., M.A.(Oxon)</i>	522
Simple High Resistance Voltmeter (Suggested Circuit No. 197), <i>by G. A. French</i>	526
200 kc/s Front End, <i>by B. E. Wilkinson</i>	529
News and Comment	532
The "8-2 Special" Receiver, Part 2	534
Crystal Microphone Mixer, <i>A. Foord</i>	536
Radio Topics, <i>by Recorder</i>	539
Recent Publications	540
A Better Technique for Printed Circuits, <i>by D. J. Falcon-Uff</i>	541
100/1000 kc/s Crystal Standard, <i>by Frank A. Baldwin</i>	544
Understanding Radio, <i>by W. G. Morley</i> (Practical Project—Adding an R F Stage)	549
High Sensitivity Transistor VHF Portable, Part 2, <i>by T. Snowball</i>	554
Sound Operated Switch, <i>by J. Roberts</i>	561
In Your Workshop	563
Can Anyone Help?	569

Audio Frequency Inductance Capacitance Meter

By

SIR DOUGLAS HALL, K.C.M.G.
M.A. (Oxon).

The measurement of high values of inductance is often a problem for the home-constructor. This article describes a measuring instrument which, working from simple basic principles, is capable of measuring inductance from 7 to greater than 2,000 henrys. The instrument will also measure capacitance (non-electrolytic) from 0.002 to 1.5 μ F and can, in addition, function as a capacitance substitution box.

THE INSTRUMENT DESCRIBED IN this article will measure inductance from about 7H to 2,000H or over, and capacitance from about 0.002 μ F to 1.5 μ F. It will provide a degree of accuracy which is more than adequate for audio frequency circuits. Inductance is measured by tuning to resonance at a frequency of 50 c/s by means of a bank of close tolerance capacitors. Capacitance is measured by balancing against this same bank. In this article the unknown inductance will be referred to as L_x and the unknown capacitance as C_x .

Basic Theory

It is useful to examine the theory involved in measuring inductance by this method. Basically, known capacitance is placed in parallel with L_x , and a.c. with a frequency of 50 c/s is passed through this parallel combination. (See Fig. 1.) Current passing through will be at a minimum when the reactance of L_x and the reactance of the capacitance are equal at 50 c/s. The formula familiar for use with circuits tuned at radio frequencies, $f = \frac{1}{2\pi\sqrt{LC}}$, is then

used. We know the value of f , C can be counted up from the switches used to connect up the various capacitors at resonance, whereupon the value of L can be worked out (or read from the Table which accompanies this article). It must be remembered that, with a parallel resonant circuit, the formula used is only an approximation, since it does not take into account the resistance of the inductor, r . The presence of r makes itself known by the current which is still passed when the tuned circuit is resonating at 50 c/s. If r did not exist, no current would pass in these circumstances. The error brought in by ignoring r becomes less as the Q of the inductor increases, and it can be shown that, under condition of parallel resonance, the formula $X_L = \frac{X_C \times Q^2}{Q^2 + 1}$ holds true.¹ From

this it can be seen that the error caused by assuming that $X_L = X_C$, ignoring r , does not exceed 1% unless Q is less than 10. In practice few inductors which are in the range of measurement of this meter will have a Q of less than 10. There are occasions when the impedance offered by an inductor is more important than its reactance. The effect of r on impedance is the opposite of the effect of ignoring r in assuming that $X_L = X_C$, so that if we say that the reactance of the capacitance, at resonance, is equal to the impedance of the inductor, the error will be reduced. Let us assume that we are measuring the impedance of an inductor which has a true reactance of 10,000 Ω at 50 c/s, and a d.c. resistance of 1,000 Ω . At 50 c/s it is reasonably fair to say that $r =$ d.c. resistance so that our calculation of reactance for the inductor will be 1% high because $Q = 10$. But the impedance offered by the inductor is given by $Z = \sqrt{X_L^2 + r^2}$

$= \sqrt{10^8 + 10^6} = 10,050\Omega$ approximately. The error has now become 0.5% instead of 1%.

All the above may be rather academic as not only may internal self-capacitances play a bigger part than resistance but there are variables which come into the picture and make any accurate measurement of reactance of inductors with iron or mu-metal cores rather unrealistic. First, there is the effect of d.c. passing through the winding which tends to reduce the permeability of the core,

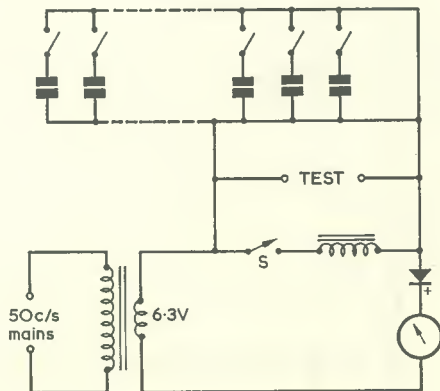

Fig. 1. The basic mode of operation of the meter. Switch S is open when inductance is being measured, and closed when capacitance is being measured

¹ The author is indebted to his brother, N. R. Hall, who until his recent retirement was a Senior Lecturer in Physics at the Royal Naval College Dartmouth, for this formula which has not, it is believed, been published previously.

COMPONENTS

Resistors

- R₁ 1kΩ ½ watt, 10%
- R₂ 15Ω 1 watt, 10%
- R₃ 5.6kΩ ½ watt, 10%
- VR₁ 2kΩ potentiometer, wire-wound

Capacitors

- C₁ 0.8μF
- C₂ 0.4μF
- C₃ 0.2μF
- C₄ 0.1μF
- C₅ 0.04μF
- C₆ 0.02μF
- C₇ 0.02μF
- C₈ 0.01μF
- C₉ 0.004μF
- C₁₀ 0.002μF
- C₁₁ 0.002μF
- C₁₂ 0.001μF
- C₁₃ 0.0004μF
- C₁₄ 0.0002μF
- C₁₅ 0.0002μF
- C₁₆ 0.0001μF

Inductor

- L₁ Transformer type TT53 (Repanco)—blue and red leads
- T₁ Heater transformer, 6.3 volts

Diode

- D₁ OA81

Meter

- M₁ 50μA moving-coil meter. Eagle MR-3P. (Henry's Radio Ltd.)

Switches

- S₁-S₁₆ s.p.s.t. toggle switches
- S₁₇ 3-pole 3-way rotary
- S₁₈ 2-pole 4-way rotary
- S₁₉ 1-pole 2-way rotary (or toggle)

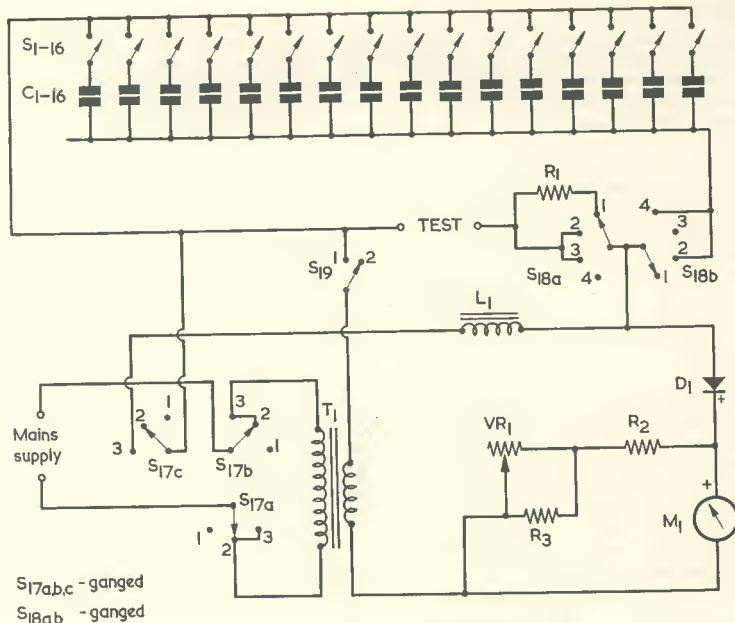

Fig. 2. The complete circuit of the meter

iron cored transformers used in valve operated equipment the inductance will vary considerably according to the a.c. passing through the winding, and measurement with these inductors should be looked upon as more useful for comparison than as an indication of accurate inductance value. Even so, the 6.3V a.c. used with this instrument represents a fair average for a number of positions in a working circuit.

Circuit Operation

In order to learn how to use this measuring instrument it is helpful to study the theoretical circuit, in Fig. 2, and then turn to the diagram in Fig. 3 which shows the switches and variable resistor fitted to the front panel of the instrument. Fig. 3 is, in fact, a scale drawing of the front panel of the prototype. It should be noted that VR₁ presents minimum resistance when it is rotated fully anti-clockwise.

and hence the inductance. The a.c. passing through L_x in this instrument changes inversely with the inductance and the effect of the resultant d.c. will be small and well within the limits applying, in practice, to small inter-transistor transformers. With large, iron cored chokes, the d.c. will be less than is likely to be involved in the circuit in which the choke will be used and with these inductors the reading can be taken as for nil d.c.

With small, mu-metal cored transistor type transformers, experiment showed that halving or doubling the a.c. through them had little effect. With these transformers it can be said that the figure given by the meter for inductance will be near enough to that which will apply in a normally designed circuit. But with the larger

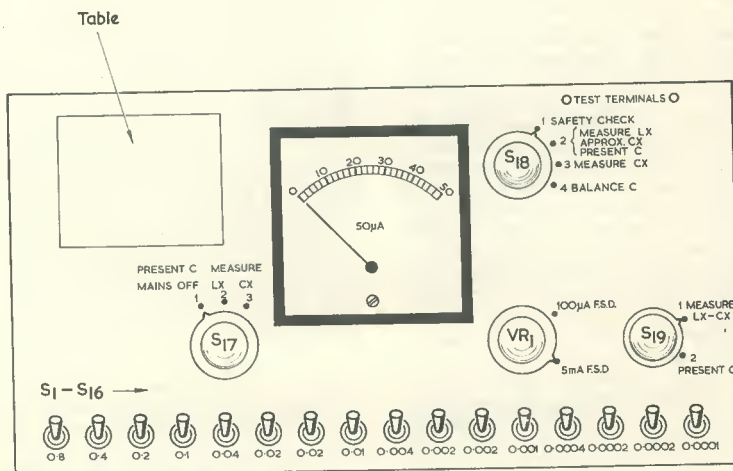

Fig. 3. Front panel layout of the instrument showing, also, the control functions. The Table for inductance values may be cut out, or copied out, and fitted in the space indicated

In the explanation which follows, it should be assumed that S_{19} is always closed. Its effect on circuit operation, when open, is dealt with near the end of the article.

Let us first state that we wish to measure the inductance of the primary of a transformer. Its leads are taken to the Test terminals and it is confirmed that S_{17} , S_{18} and VR_1 are all in the most anti-clockwise position, and that switches S_1 to S_{16} are all in the off position. The mains plug is taken to the mains supply and S_{17} is turned to position 2. While S_{18} remains at position 1 there is a resistor R_1 in series with the Test terminals which limits current and safeguards the meter in the event of a short-circuit in the winding, or of an inductance too low for measurement (below 6.7H). If, with S_{18} at position 1, the needle shows a deflection greater than about $\frac{2}{3}$ full scale, it should not be attempted to measure the inductor which produces this deflection.

At this point it might be mentioned that the meter specified has an internal resistance (not shown on the meter) of 1,450 Ω . (Also not shown is the polarity of the terminals. Positive is on the left, looking at the back.) It can be seen that with the values given for VR_1 , R_2 and R_3 , the meter will read approximately 5mA f.s.d. with VR_1 fully anti-clockwise and approximately 100 μ A with VR_1 fully clockwise. If a different meter is used it will be necessary to measure its resistance and change R_2 and R_3 if necessary. R_2 , in ohms, should equal the resistance of the meter divided by 100. R_3 , in ohms, should

$$\text{equal } \frac{2,000 \times \text{meter resistance}}{2,000 - \text{meter resistance}}$$

The resistors actually used can be taken from the nearest preferred value, as great accuracy is not called for.

Once it has been decided that the inductor is suitable for measurement, S_{18} should be turned to position 2. If the reading on the meter is low it should be increased by turning VR_1 in a clockwise direction, but this process should be carried out very cautiously in the first instance as with small inductances the effect of turning VR_1 is very rapid. When a satisfactory deflection of, say, $\frac{2}{3}$ full scale has been obtained, L_X should be tuned by operating S_1 to S_{16} . Small capacitances should be switched in first as the introduction of large capacitance could run the needle off the scale if the reactance of the capacitor were small compared to the reactance of L_X . Therefore, in the first instance, 0.001 μ F should be switched in.

The needle may move down a fraction. Next try 0.004 μ F. The deflection downwards will probably be larger. Continue introducing capacitance in steps of 400 to 500% until it is seen that the needle starts moving upwards. It will then be known that the tuning point has been passed and that it lies between the last two capacitance totals tried. At this stage the needle will probably be well down the scale and can be brought back to about $\frac{2}{3}$ f.s.d. by turning VR_1 in a clockwise direction. For the final, accurate reading, the needle should be as high as possible (its movement will be limited with very high inductance coils) as the meter will then be in its most sensitive condition for registering small changes of current. The appropriate switches in the $S_1 - S_{16}$ line are finally tried until the lowest possible reading of the meter, for any one position of VR_1 , is obtained. What the actual meter reading is does not matter. It does matter that the meter needle should be incapable of further downward movement by altering any of the switches S_1 to S_{16} .

It will be found that with large inductances a variation of 2.5% in capacitance will register, even though the needle may not be high on the scale with VR_1 fully clockwise. With smaller inductances the Q is likely to be lower and this will make tuning broader, and it may be difficult to notice any deflection caused by a change of up to 5% or so in capacitance.

When the exact tuning point has been found, and noted, as read from switches S_1 to S_{16} , the resultant inductance can be read from the accompanying Table or, if necessary, worked out. A good degree of accuracy can be obtained by dividing 10 by the capacitance in μ F, the result being in henrys. Finally, with the switches S_1 to S_{16} still in position for tuned circuit resonance (minimum current reading) VR_1 may be turned fully anticlockwise, whereupon the meter will read the d.c. passing through L_X with an f.s.d. of 5mA. If the reading is less than 100 μ A (1 division on the scale) VR_1 may be turned fully clockwise to give a more accurate reading with an f.s.d. of 100 μ A.

Measuring Capacitance

In order to use the instrument for measuring capacitance, S_{17} should be turned to position 3. From Fig. 2 it will be seen that L_1 has now been introduced into circuit, and is connected across the Test terminals. The inductance of the component specified offers a reactance, at 50 c/s,

which is, logarithmically, about half way between that offered by the useful extremes of capacitance which can be measured.

We should now consider the effect of bringing L_1 into circuit. There will clearly be a reading as soon as S_{18} is moved to position 2 since L_1 is in the same position as L_X was when the inductance of L_X was being measured. It should also be noted that as S_1 to S_{16} are brought into circuit the current recorded by the meter will drop provided the reactance of the capacitance introduced is less than the reactance of L_1 . The current will be at a minimum when the reactance of the capacitance is equal to the reactance of L_1 , and will then rise as capacitance is further increased. This means that one identical reading on the meter can be given by two widely differing capacitances, one smaller than that which tunes L_1 to 50 cycles, and one larger. When the smaller capacitance is selected, a further small increase in capacitance will reduce the reading. When the larger capacitance is selected a further increase in capacitance will increase the reading. Provided, therefore, we know the value of capacitance which tunes L to 50 c/s, we shall know where we are when measuring C_X since we can check the result of small increases in capacitance.

It is necessary, therefore, as part of the setting up of the instrument to measure the capacitance which tunes L_1 to 50 c/s, and this can be done with S_{17} at position 3 and S_{18} at position 2 and proceeding as though there were an unknown inductor across the Test terminals. Let us suppose that the answer is 0.05 μ F. It will be near this figure with the winding specified for L_1 .

We may now connect C_X to the Test terminals. S_{17} is at position 3 and S_{18} at position 2. VR_1 is adjusted for a reasonable deflection and S_1 to S_{16} are all in the off position. Starting with small values, S_1 to S_{16} are switched in until a movement of the meter is noticed. If the movement is downwards, it can be taken that C_X is less than 0.05 μ F. If it is upwards, C_X is either exactly 0.05 μ F or greater than that. There will, therefore, be no confusion, and an approximation has already been reached.

Next, with S_1 to S_{16} all in the off position, and VR_1 providing a low deflection, S_{18} is turned to position 3. It will be seen from Fig. 2 that this removes all internal capacitors from circuit and leaves only C_X across the Test terminals. Note the reading given by the meter and switch S_{18} to

position 4. This removes C_X from circuit. As there is now no capacitance in circuit the needle may rise considerably owing to lack of current opposing that passing through L_1 . Hence the need for the previous low position for the needle. Capacitance is now brought into circuit by switches S_1 to S_{16} , starting, as usual, with fairly small values, until the needle reads about the same as that noted for C_X when S_{18} was at position 3. VR_1 can now be adjusted to bring the needle up the scale for more accurate indications. S_{18} should be turned backwards and forwards between positions 3 and 4, with small adjustments of capacitance being made to S_1 to S_{16} , until there is no movement of the needle as S_{18} is moved from one position to the other. The capacitance of C_X can then be read off from the switches S_1 to S_{16} .

Capacitance Substitution Box

A further use of the instrument is as a capacitance substitution box. For this purpose S_{19} is opened (position 2) and no connection to the mains is required. S_{17} is turned to position 1 and S_{18} to position 2. Any capacitance from $0.0001\mu F$ to $1.6\mu F$ can now be presented at the test terminals in steps of $0.0001\mu F$. This can save much time in finding the optimum capacitance for certain positions in a circuit—an optimum which can vary quite a bit with different characteristics of different components, particularly transistors. ²

Construction

There is no difficulty in construction except that the proper selection of capacitors for C_1 to C_{16} is important. C_8 to C_{16} can be obtained from Home Radio Ltd., as 1% close-tolerance silver-mica capacitors, but C_1 to C_7 must be made up. The instrument should be built

² To take an example, the author recently constructed a receiver using the super-regenerative "Spontaflex" circuit. (See page 676 of the May 1965 issue). It was found that with the particular transistors and frame aerials used, results were considerably improved by decreasing C_6 to $0.01\mu F$ and by increasing the capacitance offered by the trimmer VC_2 by shunting a fixed capacitor of about 500pF across it.

TABLE

Values of capacitance and inductance for resonance at 50 c/s. (If C is divided by 10, multiply L by 10. If C is divided by 100, multiply L by 100. For values of C not shown, the approximate equivalent for L can be found by dividing 10 by C.)

C (μF)	L (H)	C (μF)	L (H)
1.5	6.75	0.55	18.4
1.4	7.24	0.50	20.3
1.3	7.79	0.45	22.5
1.2	8.45	0.40	25.3
1.1	9.21	0.37	27.4
1.0	10.1	0.35	29.0
0.95	10.7	0.32	31.7
0.90	11.2	0.30	33.8
0.85	11.9	0.27	37.5
0.80	12.7	0.25	40.5
0.75	13.5	0.22	46.0
0.70	14.5	0.20	50.7
0.65	15.6	0.19	53.3
0.60	16.9	0.17	59.6

complete, except for C_1 to C_7 . Then, with S_8 to S_{16} all switched on, capacitors are added at the Test terminals until an exact balance has been found as already described. This group of capacitors is then $0.0199\mu F$, which is near enough to $0.02\mu F$. The appropriate leads are soldered together and the group is put on one side as C_7 , and the process is repeated for an exactly similar capacitor for C_6 . C_6 and C_7 are then connected up to S_6 and S_7 and, with these switches on but S_8 to S_{16} off, C_5 is produced by balancing up at the Test terminals. C_5 is now wired to S_5 and the procedure is repeated until C_1 has been made up and connected to S_1 , whereupon the instrument is then complete. Making up the capacitors will have a familiar flavour to those who have used a laboratory balance. It is necessary to have a fair supply of capacitors for making up C_1 to C_7 , and many constructors will already have ample in their spares box.

A final point is concerned with the stray capacitances which are inevitable with the wiring and switches for C_1 to C_{16} . With all switches, S_1 to S_{16} , open, some stray capacitance will still inevitably be present. The writer used ordinary toggle switches in the prototype, and it was found

that the stray capacitance in the capacitor bank with all switches open was only 12pF. With this figure, the error in measuring inductances in excess of 2,000H, or capacitances as low as $0.002\mu F$, is very small. Even if the stray capacitance were up to 5 times that in the prototype, the error at these extremes of capacitance and inductance would still be reasonable.

However, the stray capacitance in the meter becomes more important when the instrument is to be used as a substitution box, and should preferably be taken into account. If desired, the stray capacitance can be measured if the constructor has a simple receiver available with a single tuned circuit. Leads should be soldered to the tuning capacitor of the receiver and taken to the Test terminals of the meter. Then, with S_{19} in position 2, S_{17} in position 1, S_{18} in position 2, and S_1 to S_{16} all switched off, the local station is tuned in on the receiver. The leads are then removed from the Test terminals and taken, instead, to various fixed capacitors until one is found which brings in the local station without retuning the receiver. This capacitor will be equal to the stray capacitance in the meter.



MOBILE RALLY — MOTE PARK — MAIDSTONE

A Mobile Rally and Hamfest is to be held at Mote House, Mote Park, Maidstone, Kent, on Sunday June 11th from 1200 to 2000 hours.

All profits will be donated to the Home for Muscular Dystrophy Patients.

Further details may be obtained from the Mobile Rally Committee Chairman, W. E. Nutton, G6NU, 42 Richmond Road, Gillingham, Kent.

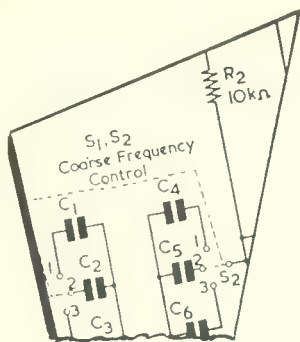

Simple High Resistance Voltmeter

SUGGESTED CIRCUIT No. 197

By G. A. FRENCH

IN EXPERIMENTAL AND SERVICING work it is sometimes necessary to use a voltmeter which consumes an extremely low current. At the same time, however, the need for a high resistance voltmeter may not be sufficiently great to merit the construction or purchase of an expensive instrument. It is to satisfy this requirement that the present "Suggested Circuit" has been developed.

The circuit presented this month is for a voltmeter which, with most transistors of the type specified, should have a sensitivity of $200k\Omega$ per volt, this corresponding to a full-scale deflection current of $5\mu A$. If the particular transistor employed happens to have a low gain the instrument may possibly have a sensitivity worse than $200k\Omega$ per volt, but it is doubtful if this will be lower than $100k\Omega$ per volt. The instrument is direct-reading, and has a linear scale on all voltage ranges. To keep cost to a minimum, no precautions against drift with changes in room temperature have been taken, results with the prototype indicating that such drift can be readily compensated for by the Zero-Adjust control of the instrument. Three potentiometers, of which two are preset and one is the Zero-Adjust control just referred to, are incorporated, and these are set up by means of a very simple procedure. The two preset potentiometers could be miniature skeleton types, if desired.

It should be pointed out that, although the voltmeter described here is capable of giving a good performance, the simplicity of its design may cause it to have a lower long-term stability than would be given by a more expensive instrument. The

accuracy of the present meter may be easily checked, from time to time, by the simple process of applying it to a known voltage. If any error in voltage reading exists, this may then be corrected by a readjustment of the preset controls. Judging from the results given by the prototype, it would appear that such readjustments should be required very infrequently.

The Circuit

The circuit of the voltmeter appears in Fig. 1, in which diagram it will be seen that a $0-100\mu A$ moving-coil meter is connected in the collector circuit of a silicon transistor type OC202. The voltage to be measured is applied to a resistor network in the base circuit, whereupon the current amplification offered by the transistor enables an effective sensitivity to be obtained which, with most transistors, should be at least 20 times greater than that offered by the meter on its own.

To obtain a linear indication in the meter it is necessary to bring the transistor on to a linear section of its base current/collector current characteristic. This is achieved by means of R_1 and R_4 . The base current passing through R_1 causes a collector current of about $0.7mA$ to flow in R_4 . The OC202 has a minimum h_{fe} of 25 at a collector current of $100\mu A$, and a minimum h_{fe} of 40 at a collector current of $1mA$, whereupon, under the conditions in the present circuit, a minimum h_{fe} of slightly less than 40 can be assumed. The $0-100\mu A$ movement used in the prototype had the typical internal resistance of 480Ω , which meant that it achieved f.s.d. with approximately $50mV$ across it. An increase

of $50mV$ across R_4 corresponds to an increased current of $30\mu A$ through this resistor. The meter registers, therefore, approximately three-quarters of any change in collector current due to change in base current (the remaining quarter flowing in R_4). The result is that a minimum-gain transistor should enable an f.s.d. of $100\mu A$ to be given in the meter for a change of slightly less than one-thirtieth of $100\mu A$ in base current. But these are only rough figures, and the author would prefer to err on "the safe side" by suggesting that it would be reasonable, in practice, to assume a minimum f.s.d. sensitivity of, say, one-twentieth of $100\mu A$ (i.e. $5\mu A$) with all but exceptionally low-gain transistors. The transistor used in the prototype provided a minimum f.s.d. sensitivity of approximately $3\mu A$.

It will be seen from the last paragraph that it is desirable for R_4 to have a relatively high value, and the values chosen for this resistor and for R_1 offer a practical compromise which just brings the transistor comfortably on to the linear part of its base current/collector current characteristic.

It is intended that, when the only current flowing in the base-emitter junction of the transistor is that due to R_1 , the $0-100\mu A$ meter should read zero. In consequence, R_5 is adjusted for zero deflection in the $0-100\mu A$ meter when the circuit is in this condition. Test voltages applied to the voltmeter then cause the base to go more negative and the collector to go more positive. These test voltages cause, therefore, a forward deflection in the $0-100\mu A$ meter.

The voltages the voltmeter is to

read are applied via a range switch and multiplier resistors, these being shown in the diagram as S_1 and R_{10} to R_{14} . It is necessary to provide a Common Positive terminal and this should have the same potential as has the base of the transistor when the only current flowing in the base-emitter junction is that due to R_1 . Since TR_1 is a silicon transistor, this potential will be about 0.4 volts negative of the emitter, and it is obtained from the slider of the Zero Adjust potentiometer, R_8 . R_8 is set up so that zero deflection is given in the 0-100 μ A meter when no voltage is applied to the instrument.

Preset potentiometer R_3 , in series with switch S_2 and resistor R_2 , is connected between the base of the transistor and the slider of R_8 . Its function is to reduce the sensitivity of the voltmeter to a convenient round number, this being 5 μ A for all but exceptionally low-gain transistors. The resistive path provided by R_2 and R_3 also tends to swamp any effects given by changing emitter leakage currents which, although small at room temperatures in the OC202, should still not be ignored. No attempt is made to counteract changing collector leakage current. When the temperature of the transistor in the prototype was artificially increased, the 0-100 μ A meter showed a small forward deflection with zero volts applied to the voltmeter. It was found that this forward deflection could be corrected by R_8 on its own with no loss in the accuracy of readings, whereupon it was considered that, for an inexpensive instrument of this nature, no further precautions against changes in collector current due to changes in temperature were required. The prototype was left switched on for several hours at normal room temperature, and no shift in the zero setting occurred during this time.

The switch S_2 , in series with R_3 , is employed only during setting up, and is not operated when using the instrument. It should, in consequence, be mounted inside the meter case and not on the panel. R_2 is merely a limiting resistor and prevents the flow of excessive base current should R_3 and R_8 be accidentally maladjusted.

Any voltage ranges desired by the constructor may be provided, the multiplier resistors and range switch shown in the diagram being intended only as examples of what is required. The resistors shown have values corresponding to 200k Ω per volt, and alternative ranges could be provided by following the same principle. Thus, a 20 volt range would require a multiplier resistor of 4M Ω . The

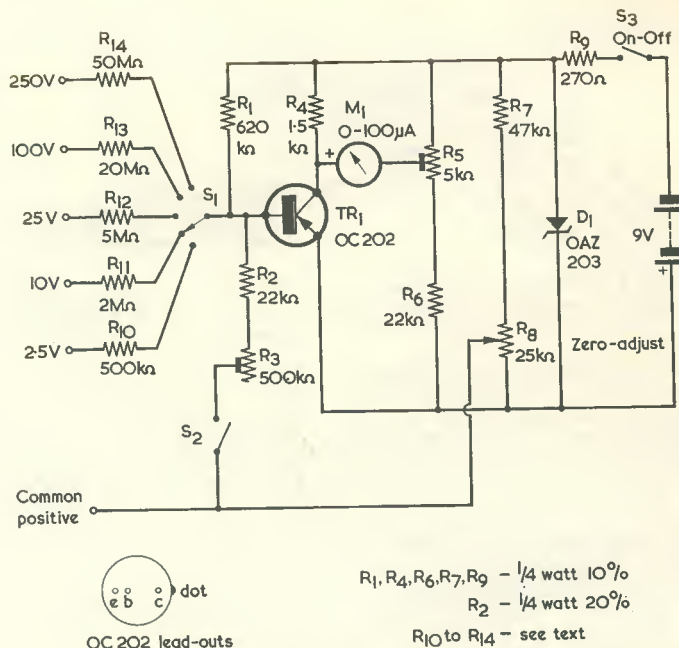

Fig. 1. The circuit of the high resistance voltmeter

constructor should *not*, however, obtain any multiplier resistors without first finding the sensitivity given with the particular transistor employed.

It is essential to provide the voltmeter with a stabilised supply. This is provided by means of the zener diode D_1 , the OAZ203 specified having a zener voltage lying between 6.1 and 6.8 at 5mA.

Setting Up

The voltmeter should first be assembled and all components wired up with the exception of the range switch, S_1 , and the multiplier resistors. Also required is a source of known voltage, which can be given by a 6-volt battery, a potentiometer and any standard voltmeter, as shown in Fig. 2. A close-tolerance resistor to function as a temporary 200k Ω per volt multiplier is needed, and this could conveniently be a 500k Ω component (for an f.s.d. of 2.5 volts) or a 1M Ω component (for an f.s.d. of 5 volts). One end of this resistor is temporarily connected to the junction of R_1 and R_2 , the other end being soldered to a flying lead. A secondary function of this resistor is to limit transistor base current during setting up.

The first process in setting up consists of adjusting preset potentiometer R_5 . With the 9-volt battery

disconnected, set this potentiometer to approximately mid-travel, open S_2 and ensure that no connections exist to the flying lead from the temporary multiplier resistor or to the Common Positive test terminal. To cater for different transistors, R_5 has rather a wide range of control and the 9-volt battery should be initially applied for a very short period only, since the 0-100 μ A meter may initially suffer fairly heavy deflection. A good plan is to leave one of the battery clips disconnected, switch on S_3 , then cause the free battery clip to be very quickly applied to and removed from the corresponding battery terminal. If the needle of the 0-100 μ A meter is rapidly deflected in the forward direction, adjust the slider of R_5 through some 30° towards R_6 and repeat the operation. If there is a meter deflection in the reverse direction, adjust the slider of R_5 through some 30° towards the negative supply line. It should soon be possible to find a setting in R_5 which causes the meter to give an on-scale forward deflection. The 9-volt battery may then be connected up properly, after which R_5 is adjusted for zero reading in the 0-100 μ A meter.

The panel-mounted Zero Adjust potentiometer, R_8 , is next set up. This should be adjusted to mid-travel, after which the flying lead

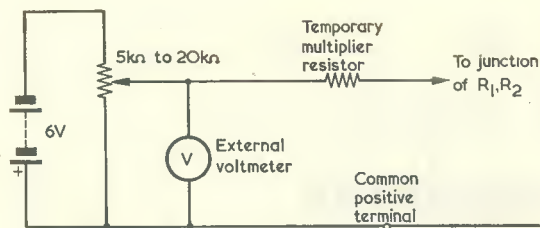

Fig. 2. During initial setting up, the Common Positive terminal, and a lead from a temporary multiplier resistor, are connected to a battery and potentiometer as shown here

from the temporary multiplier resistor should be quickly applied to and removed from the Common Positive terminal. Again a quick connection required as there may be a fairly heavy initial deflection in the meter. A forward deflection infers that R_8 slider is too close to R_7 , and a backward deflection that the slider is too close to the positive supply line. A setting for R_8 which gives an on-scale reading will soon be obtained, after which the flying lead from the temporary multiplier may be left connected to the Common Positive terminal. R_8 is then finally adjusted for zero reading in the 0–100 μ A meter.

The next process consists of checking the sensitivity of the instrument. The battery and potentiometer arrangement of Fig. 2 is made up, with the potentiometer adjusted to give zero volts. The Common Positive terminal of the instrument and the flying lead from the temporary multiplier resistor are connected as shown. The potentiometer across the battery is advanced, whereupon the 0–100 μ A meter should give a continually increasing forward reading. When the 0–100 μ A meter has reached f.s.d. the applied voltage, as indicated by the external

voltmeter, should be read. If this is lower than the 200k Ω per volt figure given by the temporary multiplier resistor, then the overall f.s.d. sensitivity of the instrument is better than 5 μ A. Set preset potentiometer R_3 to insert full resistance, close S_2 , and reduce the value of R_3 until f.s.d. in the 0–100 μ A meter corresponds to the correct 200k Ω per volt figure for the temporary multiplier. The voltmeter is then set up and the temporary multiplier resistor may be removed. In use, the only further adjustments required will be an occasional slight adjustment to R_8 .

If the previous test indicated that voltmeter sensitivity was worse than 5 μ A, then R_3 is adjusted for the next round ohms-per-volt figure. This could be 150k Ω (6.7 μ A) or 100k Ω per volt (10 μ A).

After setting up, the appropriate multiplier resistors and switch may be wired up. The multiplier resistors will, of course, require different values to those shown in Fig. 1 if the final sensitivity is other than 200k Ω per volt.

Should subsequent setting up operations be required, the temporary multiplier resistor just referred to is not needed. R_5 is set up for zero

reading with S_2 open and no voltage applied to the instrument, after which R_8 is set up with S_2 closed. R_3 is finally adjusted on any voltage range with the instrument connected to a known voltage.

Practical Points

Construction should give rise to few problems as the components employed are quite standard. Good quality insulation is needed in the base circuit of the transistor, and for the multiplier resistors and range switch, because of the high resistances involved. S_2 , R_3 and R_5 are mounted inside the case, whilst S_1 , S_3 and R_8 are fitted on the front panel.

An important point to remember is that the base circuit of TR₁ is at high impedance. *Do not, in consequence, apply a mains operated soldering iron to any components directly connecting to the base of the transistor whilst the voltmeter is switched on.* The bit of a mains soldering iron can carry an appreciable 50 c/s voltage due to leakage and self-capacitance and this voltage may cause damage to the transistor. It would be preferable also to ensure that the voltmeter is in no way connected to earth when soldering connections in the transistor base circuit.

The prototype gave good results, with no noticeable zero drift during periods of continual operation over several hours. The zero setting for R_8 held good with the test leads both open-circuit and short-circuited. The linearity of the readings given in the 0–100 μ A meter tallied well with the readings given by the external voltmeter when using the circuit shown in Fig. 2. The range of multiplier resistors shown in Fig. 1 coped satisfactorily at the voltages noted.

The current drawn from the 9-volt battery was approximately 10mA.



New Die-cast Boxes by STC

Electronic Services—STC, the "fast despatch" organisation, which supplies components by return of post, has introduced a range of aluminium die-cast boxes which offer the maximum adaptability for equipment construction.

Produced in a logical sequence of five sizes to be compatible with the ISEP modular construction system, they feature internal slots for sliding—and thus ease of fitting—screens and printed circuit boards. Box sizes range from 4 $\frac{1}{2}$ x 3 $\frac{1}{2}$ x 1 $\frac{1}{2}$ in. deep to 10 $\frac{1}{2}$ x 6 $\frac{1}{2}$ x 2 $\frac{1}{2}$ in. deep.

Specially designed ranges of Veroboard of suitable depth are available to provide an almost infinite variation of component layout and interconnection arrangements. Box cover edges are double-screened to provide complete external shielding. Thus boxes can be used as screened sub-assemblies and, since they are compatible with ISEP, such assemblies can be attached to plug-in boards.

The robust aluminium construction of these boxes, coupled with their shape and their ease of adaptation, make them suitable for a wide variety of applications. They can be used as rigid chassis for mounting in instrument cases such as Datum "Dinki cases", conveniently shaped junction boxes, compact test sets and other complete equipments.

Like the other ten thousand items stocked by Electronic Services, the new die-cast boxes are available by return of post.



If you live in an area where the 200 kc/s (1,500 metres) Light Programme is received at good strength, the little unit described here may be just what you require to adapt small medium or medium/short wave sets for reception of this signal.

200 kc/s Front End

By B. E. WILKINSON

Editor's Note

The front end adaptor unit described in this article combines neat and ingenious design with a practical approach, and it is for these reasons that we are publishing it. But it must be pointed out that the output of the unit is in the medium wave band and that it may be impossible to eradicate heterodynes with medium wave stations at night-time if it is employed in areas where the 200 kc/s Light Programme signal is not received at good strength. A strong Light Programme signal should cause the appearance of a correspondingly high a.g.c. voltage in the receiver, together with reduced sensitivity to any medium wave station which could cause the heterodynes.

A further fact is that the aerial input circuits of different transistor receivers offer widely varying sensitivities.

Because of these points we recommend readers to assemble the unit temporarily as an experimental project only, and to then check it with the transistor receiver with which it is to be used. If results are satisfactory the unit may then be built up in permanent form.

DESIGNED FOR USE WITH SMALL TRANSISTOR receivers without a long wave band, the front end described here is pretuned to the Light Programme on 200 kc/s. No modification to the receiver is required, and the unit is compact and inexpensive to build. The front end consists essentially of a single transistor in the dual role of oscillator and mixer. The oscillator generates a signal of about 800 kc/s, which is mixed with the output of a 200 kc/s preset tuned circuit. The resulting 600 kc/s beat is then fed to the receiver, which is tuned to accept it.

The Circuit

Fig. 1 shows the circuit diagram. TR₁ is an OC44 or other suitable p.n.p. junction transistor, and none of the components is critical, although C₄ should be greater than 200pF. In the prototype this capacitor was 270pF. R₁ is 100kΩ, R₂ is 22kΩ, while C₁ and

COMPONENTS

Resistors

R₁ 100kΩ ¼ watt 10%
R₂ 22kΩ ¼ watt 10%

Capacitors

C₁ 270pF silver-mica
C₂ 250pF trimmer
C_{3,4} 270pF silver-mica

Transistor

TR₁ OC44

Battery

B₁ 9-volt battery type PP3 (Ever Ready)

Plugs, Sockets

J₁ Miniature jack with switch (modified)
PL₁ Miniature jack plug
Plugs for receiver aerial and earth input

Miscellaneous

Small piece Veroboard, 0.15 in hole matrix (see text)
Flexible screened lead
Plastic case

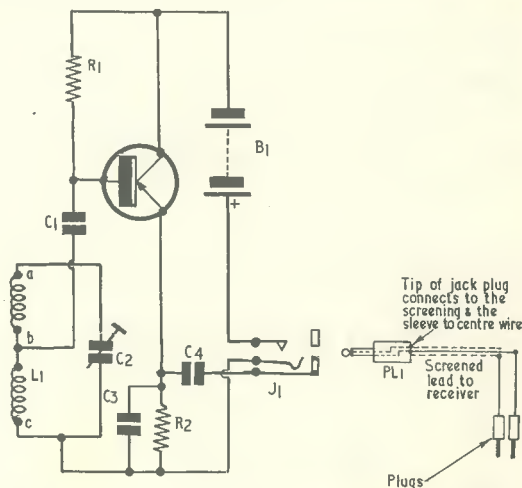

Fig. 1. The circuit of the combined mixer and oscillator which forms the front end unit. The small transistor receivers with which the unit is intended to be employed usually have a separate aerial socket, instead of the coaxial socket for car aerial familiar with the larger class of set. The mounting bush of the earphone jack normally provides the earth socket

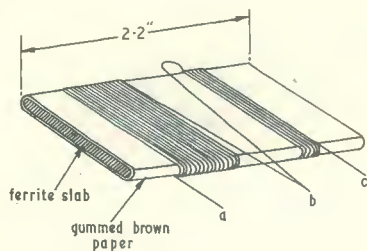

Fig. 2. Details of the inductor. The two windings are wound in the same direction

C_3 are 270pF. All the fixed capacitors in the original were silver-mica with lead-outs at the side. C_2 is a 250pF trimmer. The jack J_1 is not only a convenient method of transferring the signal output, but the "break" switch normally fitted to this type of socket is modified to "make", by suitably bending the contacts. The switch is in the positive battery line, and switches the unit on when the jack plug is inserted.

Note that the sleeve of the jack plug is at r.f. potential whilst the tip is at earth potential. This change from the usual method of connection is satisfactory here, since the jack is mounted on an insulated plastic case.

The frequency of oscillation is governed by the inductance between points "b" and "c" of the winding L_1 . The inductance between points "a" and "c" is tuned to 200 kc/s by the trimmer C_2 . The battery appears in the r.f. feedback circuit from the collector to point "c" of the winding; but it offers a low impedance at the frequencies involved and no significant improvement in performance was given in the prototype by connecting a bypass capacitor across it.

The current consumption of the prototype was 0.35mA only.

Winding the Inductor

The inductor is specially wound, and the correct number of turns determined in the following manner (see Fig. 2). A suitable winding wire is 34 s.w.g. s.s.c. copper wire.

- (a) Assemble the oscillator circuit roughly, leaving out the inductance.
- (b) Wrap a strip of gummed brown paper around a suitable length of ferrite rod or slab, and

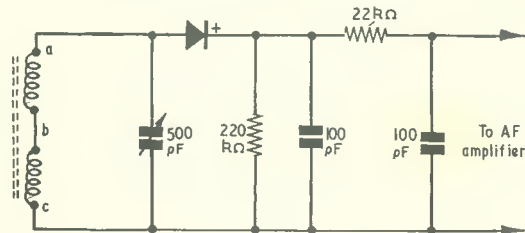

Fig. 3. A temporary crystal receiver set-up to find the required number of turns between points "b" and "a". Any germanium diode may be employed

wind on about 70 turns near one end to form the winding between "c" and "b".

- (c) Connect this coil into the circuit and connect up a 9-volt supply using short leads. Switch on the receiver and sweep the medium wave tuning range (500-1600 kc/s), until the oscillator output is found. No difficulty should be experienced in getting the circuit to oscillate, and the signal will be heard as a hiss at the receiver loudspeaker. Oscillator and receiver should be side by side for this.
- (d) Remove wire from the ferrite slab winding until the oscillator frequency is raised to about 800 kc/s (375 metres).
- (e) Disconnect the coil from the oscillator and wind on a second coil (140 turns) at the other end of the slab. Connect both windings in series across a 500pF tuning capacitor, and build into a crystal set arrangement, preferably using an a.f. amplifier. See Fig. 3.
- (f) Tune for the Light Programme, and take wire off the larger coil until the signal is received with the tuning capacitor about half open. Replace the capacitor with the 250pF trimmer, C_2 , and re-tune for the signal.

The inductor is now complete, as shown in Fig. 2. Small strips of cardboard are wrapped around the slab on either side of the windings, and the assembly is dipped in molten paraffin wax to set the turns. A strip of cardboard is then wrapped around the inductor to enclose both windings.

Constructional Details

The main constructional problem encountered by the writer in making the original model was selecting a suitable container. The unit shown in the photographs is built in a flat cylindrical plastic container with a screw lid, which previously held face cleaning pads. The inside diameter is 2.2in and the effective height 1in. Originally, the depth was greater, but a



The prototype assembly outside its plastic case

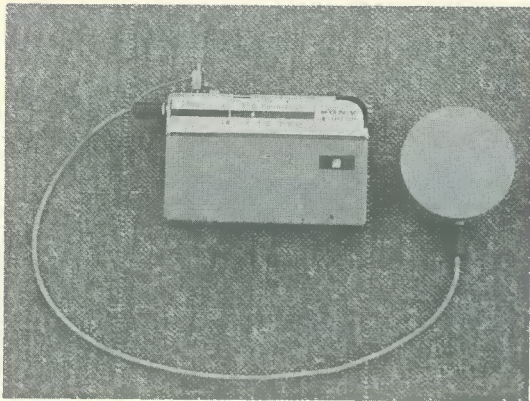

The front end unit coupled to a small medium and short wave transistor receiver

section was cut out and the case re-formed by sticking with polystyrene cement. A disc of Veroboard with 0.15in hole matrix and a diameter of slightly less than 2.2in was cut and sits loosely in the bottom of the case. The 600 kc/s signal is taken from the unit to the receiver via the miniature jack socket fitted in the side of the case. A ferrite slab is used as an aerial, the length being equal to the internal diameter of the container. It was found necessary to radius the ends of the slab, and this was most effectively done by grinding on emery paper. The ferrite aerial is bound to the Veroboard disc with thread, and the 9-volt PP3 battery rests on top. A small piece of plastic foam, stuck to the screw lid, bears on the battery, and holds the components firmly in position when the lid is screwed down. The tuning capacitor C_2 (250pF trimmer) is mounted on a Z-bracket secured to the Veroboard with a 6BA nut and bolt. Although the arrangement shown in the accompanying photograph is satisfactory, the layout is by no means critical, and the reader may find a container of a different shape which he considers more suitable.

The circuit is wired up as shown in Fig. 4, the vertical lines on the disc representing conducting strips at the back. With a Veroboard disc of 2.2in diameter, some 14 strips are available, although only 7 are used. The battery terminal clip, for use with the PP3 battery, is taken from an old PP3 battery. Connection between front end and receiver is by means of a short length of coaxial microphone cable. The signal is applied between aerial socket and earth, the latter, with smaller receivers, usually being the visible part of the receiver's earphone socket. The coaxial cable thus divides at the receiver end, and is fitted with two suitable plugs. Capacitance in the coaxial lead will have an effect if great enough, so that the length should be kept down. A foot or so is satisfactory.

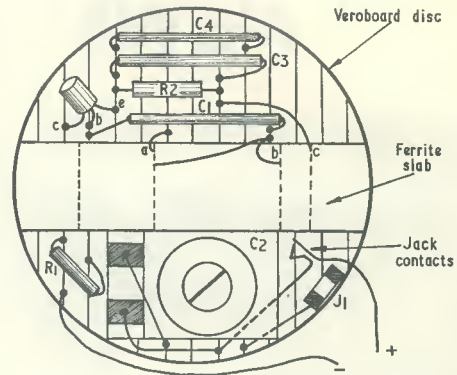

Fig. 4. The prototype assembly. The ferrite slab lies flat above the component side of the Veroboard disc. The vertical lines represent the centres of the copper strips on the underside of the Veroboard

Setting Up

Setting up the front end is not difficult, but is simplified by following a logical procedure.

- (a) Connect the coaxial lead to the aerial and earth input of the receiver, and insert the jack plug into the front end socket.
- (b) Switch on the receiver, and tune to about 800 kc/s. Check that the oscillator frequency has not changed, and if it has, note the new value.
- (c) Connect several feet of aerial wire to the non-earthly side of the 250pF trimmer, C_2 . Move the receiver frequency down 200 kc/s—i.e. to 600 kc/s (500 metres).
- (d) Now adjust the trimmer for the Light Programme. It may be necessary to “search” the 600 kc/s region with the receiver, but the signal should be found without much trouble.
- (e) Remove the short aerial and re-tune the trimmer, if necessary. Remember that the ferrite aerial is directional, and it may be necessary to rotate the front end unit.

The above procedure should be carried out during the day, when the medium waveband is not too overcrowded. However, it is possible that the beat frequency will coincide with a station, so that the receiver output will consist of two signals. The unwanted signal can be eliminated, if it is not too strong, by rotating the receiver to misalign its ferrite aerial. If interference persists, a small capacitor should be connected across the oscillator winding between points “b” and “c”. This will reduce the oscillator frequency and shift the front end output from the interfering signal.



MOBILE RALLY — DRAYTON MANOR PARK, TAMWORTH

The North Midlands Mobile Rally formerly at Trentham, is taking place this year at Drayton Manor Park Near Tamworth, Staffordshire on Sunday 30th April, 1967. (A5 to Frazeeley Roundabout signpost to Drayton Manor Park).

NEWS . . . AND .

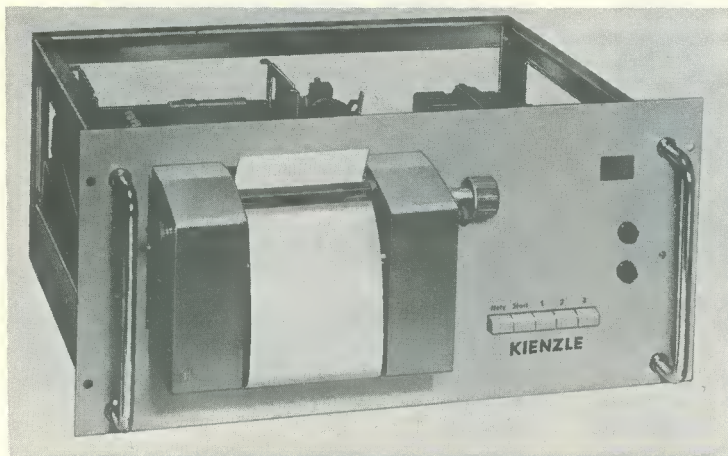

Kienzle Printer Type D4

RADIATRON announce that their Digital Printer Type D4—designed to print out from binary coded decimal information without the need for additional electronics—can now accept a minimum voltage difference of 2 volts between the “0” and “1” states. It can, therefore, print out from integrated circuits directly. The number of digits which can be printed has been increased from 14 to 16.

This printer can be supplied, as the Types D11 and D14 either as a bench mounting for strip printing, or with a wide carriage, or as a 19in. rack mounting unit.

TELEVISION BLUNDERS

The editorial in the March issue of *Safety*, the journal of the British Safety Council, which appeared under the above heading we think will interest many of our readers and we reproduce extracts herewith—

As a mass communication media, television is a sitting duck for criticism. But seldom has criticism been more warranted than that levelled by the British Safety Council last week concerning two weekend ITV programmes.

On Saturday night, Charlie Drake in “Who is Sylvia?” stuck two fingers in a power socket, slashed his wrists with a knife, and levelled a gun at his head—all apparently in good clean fun.

But it is not quite so clean. The “Batman” cult has resulted in death and injury—so much so that Batman and Robin now have to appeal to children, before each programme, not to try and emulate them.

Mr. Tye described the perpetrators of the aforementioned actions as “Simple Simons of the small box.” He called for a “swift and searching inquiry.” He was right.

Lord Hill, of Luton, chairman of the ITA, in his reply, said: “You will know that Independent Television has devoted a great deal of effort to support the work of the national safety organisations, and we have also tried with a fair degree of success—to be very safety conscious in our general programme output. . . .”

Transipads For Miniature Encapsulated Transistors

Specifically designed to accommodate encapsulated transistors with in-line leads, these new Transipads prevent shorting between leads, and provide ample space for reliable soldered connections to printed-circuit boards.

Model 10170 spreads leads to a diameter of 0.100in. requiring only 0.240in. diameter of printed circuit board.

Model 10171 gives a lead spread of 0.200in. diameter where board space is not at a premium.

As with each of more than 150 Transipads now current, small quantities can be provided at no charge for evaluation and stocks are available from M. Ross Co. Ltd. 14 New Road, Watford, Herts.

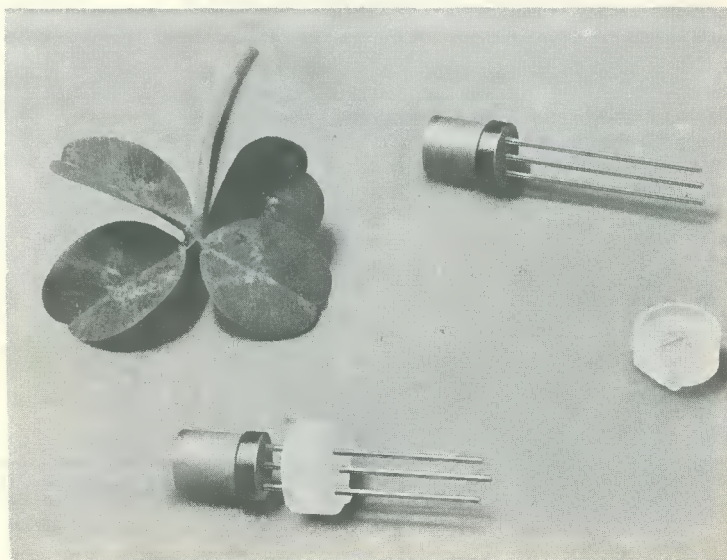

COMMENT

Quality and Reliability Year

At the Simonstone factory of Mullard Ltd., Britain's biggest television picture tube production unit, closed circuit television is being used to acquaint workers with the aims and objects of Quality and Reliability Year (October 1966—October 1967).

Programmes on various aspects of Quality and Reliability are being broadcast regularly over eight television sets placed in the factory's three canteens. Programme content ranges from the presentation of cash prizes to the winners of competitions designed to boost Q and R, to showing films such as *Right First Time* and *According to Specification* distributed by the British Productivity Council.

Recently, for instance, a cheque for £20 was awarded to Mr. Fox of the Processing Department for his poster aimed at reducing accidents and damage to equipment within the factory. As well as being shown on television, Mr. Fox's poster, which was chosen from over 60 entries, will be displayed throughout the plant. Another cash prize was awarded to the staff of the Packing Department for their efforts in improving service to the customer.

The idea of using CCTV during Quality and Reliability Year came from Mr. Funnell, the manager of the tube factory. He stressed the need for both management and workers to produce ideas for programmes. As a result a team of girls from the electron-gun assembly department are busily working on a script, and other talent in the factory is being sought for future programmes.

It is planned to relate the theme of the programmes to the six subjects of Q and R Year, namely Service to the customer, Good Housekeeping, Anti-damage, Quality troubles in the factory, Learning for Q and R and Consolidation of Q and R gains.

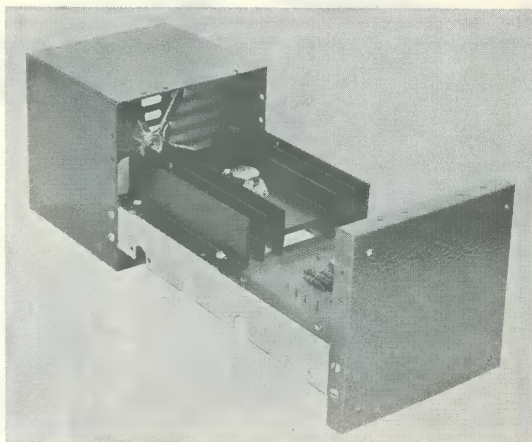

Lektrokit Cooling Unit

The Lektrokit Division of A.P.T. Electronic Industries Ltd., Chertsey Road, Byfleet, Surrey, announces an addition to its range of components available in Lektrokit Rack and Chassis construction systems.

Designated LKU.511, the Unit is primarily designed as a cooling unit for electronic equipment, especially for improving the efficiency of transistor heat sinks and for lowering the temperature level inside assemblies as an aid to reliable operation and stability generally. Although the Unit is dimensioned to fit into both Chassis and Rack System constructions, it can be incorporated into the design of any electronic equipment.

The housing measures 5 × 5in. (12.7 × 12.7 cms) across the opening and it is 4.5in. (11.4 cms) deep. Fixing holes are provided to enable the cooling unit to be used as a replacement for the normal side plate of any Lektrokit assembly with the Chassis rails bolted to it.

In operation the unit provides an air displacement of approximately 2,000 cu. ft/hr (56 cu. cms/hr) under conditions of reasonably free air flow. The fan blades are driven by a fractional h.p. 200/250 V a.c. motor. Tapped bushes (two × 2BA) are fitted on the air intake face for mounting the Unit on Lektrokit ventilation panels numbers 2 and 3.

The Unit, which is competitively priced at £3, fits into the same space as a normal Lektrokit Chassis Assembly by cutting rails LK.201 to three quarter lengths and fitting the cooling unit at one side. In this way it may be fitted into a standard 19in. rack, using normal Lektrokit mounting brackets (LK.601) for flush or proud mounting.

Further details of the LKU.511 and all other Lektrokit items are available from A.P.T.

"Holy transistors!
What are you
doing brother
Francis?"



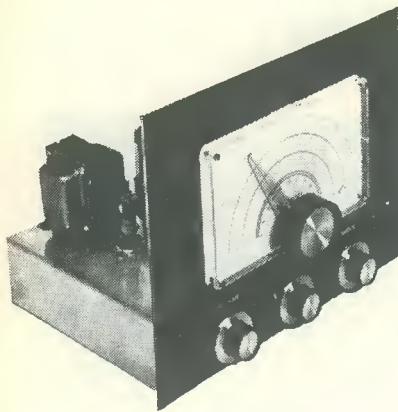

THE "8-2 SPECIAL" RECEIVER

PART 2

Wiring-Up

It is not proposed here to describe the wiring-up process in full. The below-chassis illustration clearly shows most of the components and this, together with the circuit diagram, should make the task almost self-explanatory. Several points require some clarification, however, and one of these is that, with the valveholder for V_2 , a small metal screen, approximately $\frac{3}{8}$ in wide and $\frac{3}{4}$ in high, is soldered across the holder such that pins 1, 2, 3 and 4 are screened from the remainder of the valveholder pins. The small metal screen may be cut from a discarded can from the kitchen, cleaned with lighter fuel and soldered at one end to pin 5 and at the other end to the central metal spigot. Note that a small cut-out must be made into which fits the actual spigot of the valveholder. Ensure that the screen does not make contact with C_7 moving vanes when it is soldered into position.

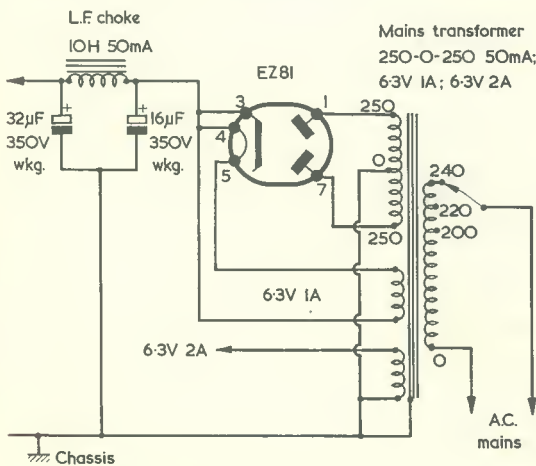

Fig. 5. A suitable power supply circuit for the receiver, as discussed in the text

Pins 3 and 4 of the valveholder should be joined to the screen by means of a small length of bare wire. The screen itself must be earthed, by means of a further short length of bare wire, to the earth tag mounted under one of the valveholder securing nuts. To the top of this metal screen are also soldered the earthy ends of R_7 , R_{11} and R_{12} , these three resistors being mounted vertically.

Note that, with the potentiometers R_3 and R_{13} , the metal casing of these components should be connected to chassis. This should be done when the respective chassis connections are made to these controls, in the manner shown in Figs. 4 (c) and (d).

The connection from C_2 , connected to the anode of $V_{1(a)}$, to pin 8 of the $L_{1,2}$ coilholder should be made by means of a length of coaxial cable, the outer metal braiding of which should be soldered to the chassis earth tag 5 of the 5-way tagstrip. Coaxial cable is also used for the connection from the centre tag of the volume control R_{13} to pin 1 of $V_{3(a)}$.

All the wiring should be short and direct and the valve heater lead should be routed well away from grid and anode circuits and as close to the chassis as possible. Each valve obtains one side of its heater supply from the adjacent chassis tag.

Fig. 4 gives the wiring-up details of the two tagstrips, and the valveholder wiring-up should be quite simple if the below-chassis illustration and the circuit diagram are followed with due care and attention. Fig. 4 also provides details of the wiring for R_3 and R_{13} .

The earth connection required for the reaction capacitor C_7 is automatically made by securing the component to the chassis and panel.

Testing the Receiver

As previously mentioned, the receiver may be tested by temporarily operating it as a two-valve design by connecting an aerial to pin 8 of L_3 .

(continued on page 538)

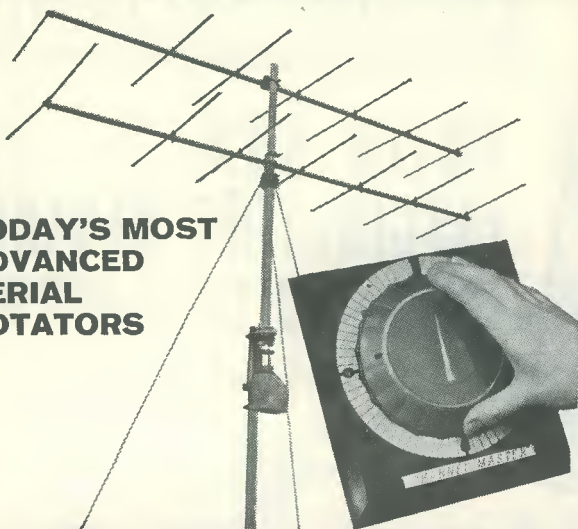
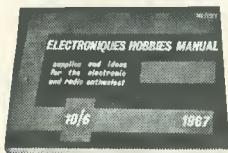
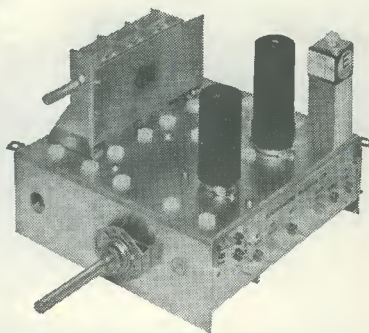
1**TODAY'S MOST
ADVANCED
AERIAL
ROTATORS****2****BRILLIANT
VALVED
QOILPAX**

I should like a copy of the Electronics Hobbies Manual. Enclosed is a cheque/P.O. for 10/6.

NAME _____

ADDRESS _____

R.C.5.

FROM THE ELECTRONICS HOBBIES MANUAL . . .

1 AERIAL ROTATORS. This range of beam rotators and accessories offers more advanced features than any other on the U.K. market—and at a lower price. The rotators can aim an aerial to within one degree of the transmitter location. No guesswork, no irritating gear clicks—just precise fine adjustment through 365° with accurate repeatability. With both models the aerial is held in place in high winds with an ingenious stop-lock brake. **COMPASS MODEL** offering remote fingertip control and continuous direction indication—£12.12.0 plus 3/6 p&p.

AUTOMATIC MODEL (illustrated) offering remote control and facility to pre-set to desired location. A synchronised motor in the control unit gives continuous indication of aerial position—£17.17.0 plus 3/6 p&p.

2 VALVED QOILPAX. If you are building a communications receiver, (whether for general coverage or hambands), why not avoid all the headaches in the front end by purchasing one of our highly sensitive 'QOILPAX' tuners. Sensitivity is 1 μ V for 15dB S/N ratio, and second channel interference is exceptionally low. The high sensitivity RF stage is designed around an EF183 connected in a Miller compensating circuit, followed by an ECH81 triode heptode frequency changer, using oscillator circuits. These give optimum mixing conductance on each waveband without any pulling. Ideal also as a converter, feeding into existing receivers. General coverage and hambands versions are available, each with an IF output of 1620 Kc/s. All units are supplied completely wired, tested and aligned. Either model £12.12.0 each plus 4/- p&p.

FREE Aerial Supplement to the Electronics Hobbies Manual. This publication MG 222S1 supplementing the Manual lists our aerial rotators and wide range of J-Beam aeriels. Send for your copy today.

For the 600 page Electronics Hobbies Manual or further details of the products displayed on this page write to: Electronics (Prop. STC Ltd.) Edinburgh Way, Harlow, Essex. Telephone: Harlow 26777.

electroniques

High-grade components for amateur communications



RADIO CONSTRUCTOR

BUILD SOME OF THE FASCINATING DESIGNS FEATURED EACH MONTH

NEXT MONTH'S SPECIAL FEATURES



Price 2/6

or 3/- by post from

Data Publications Ltd.

57 Maida Vale, London W.9.

- Radio Control Transmitter
- Signal Injector
- 2-Transistor Receiver



Crystal Microphone Mixer

By A. FOORD

In this mixer circuit the use of a "virtual earth" technique enables a number of inputs to be applied to a single valve grid with negligible interaction between gain controls

CRYSTAL MICROPHONES TYPICALLY HAVE A CAPACITANCE of the order of 2,000pF, and should be fed into a load greater than 1MΩ to avoid loss of bass. While this high input impedance could certainly be achieved with transistors, valves

are adopted in the mixer which forms the subject of this short article. These present the required impedance to the microphones and also provide voltage gain.

If the design is used as an "add-on" mixing unit for a tape recorder or valve power amplifier, the heater and h.t. currents could probably be drawn from these. The heater current requirement is 0.7 amps and the h.t. requirement some 5mA or less.

The Circuit

Each microphone input is fed to an EF86 operating under starvation conditions, with its bias provided by a high value of grid resistor. This method of operation is permissible with the low signal levels to be expected at the inputs. The outputs of the EF86's are applied to gain controls VR₁ and VR₂, these coupling, by way of isolating resistors R₄ and R₈, to the grid of V_{3(a)}.

Due to negative feedback via C₉ and R₉, a low input impedance appears at point X. Assuming a numerical voltage gain in V_{3(a)} of approximately 50, the impedance at point X (from $\frac{R_9}{50}$) is about 20kΩ. This point may, in consequence, be considered as a "virtual earth". The advantage of this method of operation is that interaction between VR₁ and

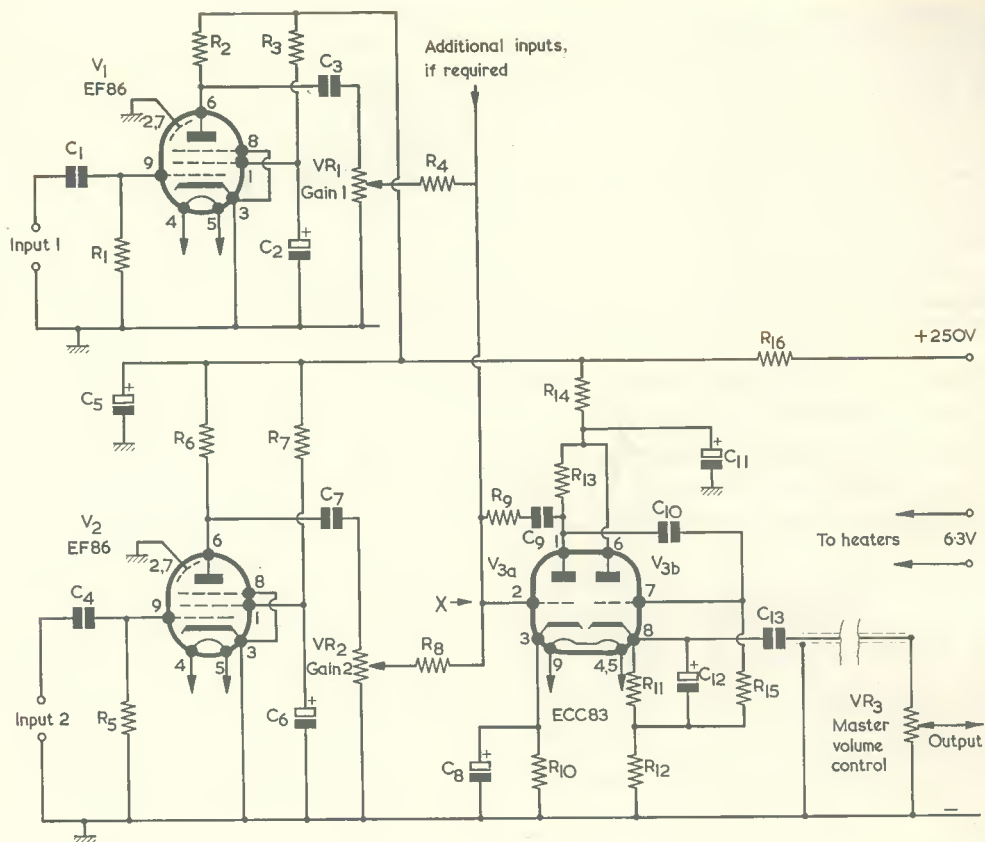

The circuit of the crystal microphone mixing unit. A "virtual earth", at point X, reduces interaction between VR_1 and VR_2 to a negligible level

Resistors

(All fixed values $\frac{1}{4}$ watt 10% unless otherwise stated)

R_1	10M Ω
R_2	100k Ω
R_3	390k Ω
R_4	470k Ω
R_5	10M Ω
R_6	100k Ω
R_7	390k Ω
R_8	470k Ω
R_9	1M Ω
R_{10}	2.2k Ω
R_{11}	1.5k Ω
R_{12}	47k Ω
R_{13}	100k Ω
R_{14}	27k Ω
R_{15}	1M Ω
R_{16}	22k Ω $\frac{1}{2}$ watt
VR_1	500k Ω potentiometer, log track
VR_2	500k Ω potentiometer, log track
VR_3	500k Ω potentiometer, log track

COMPONENTS

Capacitors

C_1	0.1 μ F
C_2	1 μ F electrolytic, 250V wkg.
C_3	0.1 μ F
C_4	0.1 μ F
C_5	16 μ F electrolytic, 250V wkg.
C_6	1 μ F electrolytic, 250V wkg.
C_7	0.1 μ F
C_8	50 μ F electrolytic, 6V wkg.
C_9	0.1 μ F
C_{10}	0.1 μ F
C_{11}	16 μ F electrolytic, 250V wkg.
C_{12}	50 μ F electrolytic, 6V wkg.
C_{13}	0.1 μ F

Valves

V_1	EF86
V_2	EF86
V_3	ECC83

VR₂ is negligible, and is certainly much lower than would be given with the more commonly met circuit where the isolating resistors after the gain controls feed to a normal grid resistor without feedback. Additional input circuits may also be applied, via 470kΩ resistors, to point X.

V_{3(b)} functions as a cathode follower and provides a low output impedance for feeding into a screened cable. This impedance is of the order of 600Ω. The master volume control, VR₃, is best positioned at the remote end of this cable.

In construction, the normal precautions should be taken against hum, particularly at the control grid circuits of V₁ and V₂. Heater wiring should be

kept well away from the valveholder grid pins and from the grid components.

Performance

The performance of the mixer may be summarised as follows:

Input impedance—10MΩ

Output Impedance (V_{3(b)} cathode)—600Ω

Maximum gain (either input)—200 times

Maximum Output—1 volt r.m.s.

Hum and Noise—50dB down at 1 volt

Frequency Response (+0 -3dB)—20 c/s to 20 kc/s

The hum and noise figure assumes that adequate attention is paid to the wiring around V₁ and V₂.



The "8-2 Special" Receiver

(continued from page 534)

Check to ensure that all the correct connections have been made and that no short-circuits exist between the h.t. line and chassis. If a testmeter is available, this is easily done by switching to a resistance range and making a continuity test between chassis and the main h.t. input point, whereupon no reading (apart from that due to leakage resistance in C₁₈) should result. If a meter is not available, when a simple continuity device may be made by means of a small battery and bulb.

TABLE I

Position	Voltage (V)
Junction R ₄ , RFC ₁	75
" R ₅ , RFC ₂	225
" R ₆ , C ₅	200
" R ₉ , RFC ₃	100
Pin 6 V ₂	175
Pin 9 V ₃	20
Pin 6 V ₃	165
H.T. Line	240
Total consumption of receiver—44mA at 240V	
Meter 20,000Ω/V. All readings taken under no-signal conditions, R ₃ and R ₁₃ at minimum	

Table I provides the various voltage readings obtained with the prototype.

Plug in the valves, the appropriate coils, aerial, earth and the two speaker connections. Switch on and wait a few moments for the valves to warm up. Bring both R₃ and R₁₃ to a point near maximum and slowly rotate the reaction capacitor C₇ until a gentle breathing sound is heard. Back off C₇ from this point and rotate the tuning capacitor C_{4(a),(b)} until a signal is heard.

It will be found that the coils, both to cover the ranges required and to produce the maximum

results, will require some adjustment and details of the results given with the prototype are shown in Table II.

TABLE II

Coil	Frequency Coverage (Actual)	Position of L _{3,4,5} slug spindle
3	1.67 to 5.7 Mc/s	½in protruding from top of former body
4	4.75 to 17.5 Mc/s	level with top of former body
5	10.5 to 32.0 Mc/s	½in protruding from top of former body
Frequency Coverage (Manufacturer's literature)		
3	1.67 to 5.3 Mc/s	
4	5 to 15 Mc/s	
5	10.5 to 31.5 Mc/s	

Note:

Once the position of the dust-iron slug has been correctly adjusted to that shown here, it may be secured in position by a 4BA nut, slight final adjustments being made by inserting a small screw-driver blade into the slotted end of the slug spindle.

The position of the L_{1,2} slug spindle in the prototype was as follows—Coil 3, ⅞in; Coil 4, ⅝in and Coil 5, ⅜in protruding from top of former body.

The "8-2 Special" receiver will be found to perform extremely well over the entire frequency coverage and will provide the operator with endless hours of enjoyment whilst tuning the various bands—both broadcast and amateur.

The last task will be, of course, to calibrate the full-vision dial and a method for this is described in the literature supplied with the dial and drive—a special cursor being supplied with the component for this purpose.



Radio Topics

by Recorder

POSSESSING A FAIRLY CONTENTED outlook on life I haven't, in the past, found myself unduly envious of other people's occupations. But I must admit that over recent years quite an alarming amount of jealousy has burgeoned forth in my soul. This green in my eye has intensified in direct proportion to the ever increasing quantity of spy and science-fiction presentations which now appear at the cinema and on TV.

I have always been rather a sucker for this sort of entertainment, having been nurtured in my youth on pretty well the whole of H. G. Wells, together with a weekly enthralled reading of a journal called *Bullseye* which pulled out every stop imaginable in the introduction of fantastic machinery for the use of the characters in its stories.

Pseudo-Equipment

Electronic equipment of all types, whether real or fictitious, has always had a magical quality for the layman, and the present spate of spy and science-fiction stories is taking the pseudo-equipment, in particular, far beyond the level which used to exist in the old days. Also, the pseudo-equipment has almost completely discarded the corniness which used to plague this venue in earlier cinema and television offerings. In the old days, and particularly in the cinema, whenever any weird and wonderful electronic equipment was required all the prop-man used to do was to pop out and have a quick dig around the surplus stores. One would see such clangerous episodes as the tuning in of signals from Outer Space on a transmitter type T1154, or the measurement of depth in an underground vehicle by the hopeful manipulation of the tuning knob on a Bendix Radio Compass. I'll always remember the thunderous

roar that rose up in the camp cinema of a war-time R.A.F. Wireless Training School when the radio operator of the aircraft in *Target For Tonight* tapped out a signal back to base by way of the TR9 R/T set.

The preparation of spoof equipment which looks as though it is actually capable of carrying out the job it is supposed to do started, I would suggest, around the early 1950's. Older readers may remember the film *Forbidden Planet*, in which the inestimable Robbie the Robot had an oversized uniselector in his head, this latching up to a fresh position every time he started to work out a new pronouncement. I think that this film marked the commencement of the more informed approach to the creation of essentially futuristic devices which is so evident today.

The much more recent James Bond films set an even higher standard in ensuring that way-out gear does bear some resemblance to what can be imagined. Do you remember that atom bomb in *Goldfinger*? Now, that was a *bomb*.

And this is where the jealousy on my part comes in. I am fully and unashamedly envious of the chaps behind the scenes whose job it is to construct pseudo-equipment for film and TV presentations. Just imagine the bliss of making up the front panel of an item of equipment whose function is to, say, blow the top off Big Ben by remote control from the Outer Hebrides. The mind boggles at the effects one could achieve. One could, for instance, start off with a really intriguing display of large black knobs and scales, all laid out symmetrically and topped by a nice neat row of meters. The knobs needn't do anything, but a couple of transistor multivibs hitched up to the meters would keep their needles hopping backwards and forwards in a most

impressive manner. At the top, of course, there would have to be a further meter, this being a whacking great job which would inevitably marked the top 20% of its scale marked up in red with the word DANGER alongside. That would be the meter whose needle would move in and out of the DANGER area whilst the hero and the villain fought over the controls during the last dramatic scene. And I would reserve the right to operate the variable resistor off the scenes which actually controlled the deflection of that meter.

Another prop which would give great satisfaction in its construction is the overgrown open knife-switch that is similarly struggled over by the hero and the villain. I'd fix that so it gave the father and mother of sparks when, eventually, the hero managed to pull it open and foil the villain's vile and dastardly plot.

The continual increase in spy and science-fiction presentations on TV and in the cinema offers boundless opportunities for the really imaginative creator of impossible devices. And the greatest attraction of all is that nobody expects any of these devices to carry out its supposed function at all! It is that last little point which finally raises to its peak my jealousy of those who have the wonderful occupation of constructing that beautiful and shamelessly false equipment.

Still, it's no good bewailing my lot. I suppose I must resign myself to my preordained station in life, and continue with the making up and servicing of gubbins which, bless their little vacuum and semiconductor socks, not only have to look reasonably presentable but have also to produce the correct sounds and/or pictures as well.

Magic Meters

Talking about equipment which isn't exactly what it appears to be, I must recall briefly a major disillusionment I underwent when Ground Control Approach equipment was starting to be generally used for the "talk-down" of aircraft coming in to land. With this equipment the aircraft was identified and brought into range on a normal radar P.P.I., and was then lined up on the glide path for the runway in use. After that it was "talked-down" by the controller until it was within visual range of the runway.

I was present at several "talk-down" sessions, and I was fascinated by two large meters in front of the

(continued on page 543)

RECENT PUBLICATIONS



BASIC PIEZOELECTRICITY. By John Potter Shields. 134 pages, $5\frac{1}{2} \times 8\frac{1}{2}$ ins. Published by W. Foulsham & Co. Ltd. Price 20s.

This book, which appears in the Foulsham-Sams Technical Books series, consists of an American text with an introductory chapter for the English reader. It offers a very useful introduction to a subject which tends to be skated over in normal electronics texts.

"Piezoelectricity" covers the whole range of piezoelectric phenomena as currently encountered, and discusses these at a level which will be particularly appreciated by the radio hobbyist and service engineer. Subjects covered include the range of available piezoelectric materials; piezoelectric transducers; crystals for frequency control; ceramic r.f. and i.f. filters ("Transfilters"); light modulation (a piezoelectric slice varies light polarisation in sympathy with an applied a.f.); ultrasonic cleaning transducers; underwater Sonar devices; and such specialised applications as spark pumps and high voltage generators. A final chapter gives 10 experiments which can be carried out with simple equipment.

The book is not intended to be exhaustive. But it does open quite a few windows on a subject which is all too rarely dealt with, and it will be of particular value to the younger engineer and the student.

Further Titles. Further titles in the Foulsham-Sams Technical Books series, similarly consisting of an American text with an introductory chapter for English readers, are detailed below.

ABC's OF ANTENNAS. By Allan Lytel. 102 pages. Price 16s.

Prepared especially for the amateur and the technician, this deals with all aerial systems up to waveguide-fed dishes.

COMPUTER BASICS: INTRODUCTION TO ANALOG COMPUTERS. By Technical Education And Management Inc. 294 pages. Price 30s.

This work deals extensively with mathematics up to complex number level and with analogue computing devices of a mechanical nature. This is the first of five volumes on basic computer principles, these being based on a course for U.S. Navy technicians. The present book does not cover electronics nor digital computer principles, but it makes engrossing reading for those who are fascinated by the relation between mathematical and physical processes.

SERVICING TRANSISTOR TV. By Robert G. Middleton. 229 pages. Price 30s.

A down-to-earth treatment for the service engineer, and liberally illustrated with set-makers' circuit diagrams, oscillograms and photos from the screen, "Servicing Transistor TV" gives a detailed approach to troubleshooting in the transistorised stages of American monochrome TV receivers. The book also provides a useful introduction to American manufacturing techniques in this field.

TRANSISTOR SUBSTITUTION HANDBOOK, 6th Edition. By The Howard W. Sams Engineering Staff. 133 pages. Price 12s. 6d.

This handbook lists thousands of replacements for American and non-American (including British) transistors, the American types predominating. American alternatives for American types may be found at a glance, but non-American substitutes for American types need a little searching. Also given are lead-out connections for all types listed.

TRANSISTOR RADIO SERVICING MADE EASY. By Wayne Lemons. 152 pages. Price 20s.

Simple advice for the serviceman on transistor radio servicing. The American circuits in the text are fairly similar to British designs, and the basic snags dealt with are the same the whole world over.

101 WAYS TO USE YOUR SWEEP GENERATOR. By Robert G. Middleton. 150 pages. Price 20s.

After a brief introduction to the basic operation of the sweep generator (i.e. frequency-modulated generator, or "wobulator") this book gives 101 actual tests which may be carried out on radio and television receiving equipment. The last 24 tests in the book apply to colour television receivers.

BASIC ELECTRICITY/ELECTRONICS LABORATORY WORKBOOK. By Training & Retraining, Inc. 230 pages, $8\frac{1}{2} \times 11$ ins. Price 35s.

This book, with a much larger page size than those detailed above, is intended for practical training purposes and takes the student through 22 "jobs" (virtually lessons) starting with voltage and current measurements and ending with the construction and servicing of a 6-valve medium wave superhet with an r.f. stage. Very clear diagrams with precise text on programmed teaching lines. Test equipment required includes a multi-testmeter, an oscilloscope, an a.f. sine and square wave generator and an r.f. signal generator.

A Better Technique for Printed Circuits

BY

D. J. FALCON-UFF

The ingenious technique described in this article enables printed circuits to be produced quickly and easily under home-workshop conditions. A further advantage is that a number of identical circuits may be produced from a single screening pattern.

PRINTED CIRCUITS CAN BE PRODUCED IN A NUMBER of ways, and it would not be out of place to give a brief description of the most common methods before proceeding to the technique which forms the subject of this article

A printed circuit may be produced quickly and simply by cutting the copper with a sharp knife, and then peeling off the unwanted copper from the board. A hook-shaped blade, made from a piece of high speed hack-saw blade, is a great help when cutting the copper. Stubborn pieces of copper may be persuaded to lift by heating with an iron.

With another method, the unwanted copper is removed by etching, the wanted copper being retained by painting the required circuit directly on the copper.

Probably the most common system used is the tape method. Tape or one of the self-adhesive plastics, as used on kitchen shelves, etc., is stuck on to the copper. The circuit is drawn on with a wax pencil. A modeller's knife or scalpel is used to cut round the circuit, the tape covering the unwanted copper is removed, and the whole is then immersed in an etching solution.

Other methods are possible, such as silk screening and the use of photo resists, but these are applicable only when large numbers of the same circuit are required.

The New Technique

In the author's view a method of producing printed circuits should be simple, the tools should not be too elaborate, and the method should lend itself to the copying of circuits. In addition to fulfilling these requirements, the technique to be described enables the amateur to produce work approaching that of the professional in quality and appearance.

With this technique, adhesive tape or plastic is applied to the copper of the board and the circuit

is cut out. The plastic covering the *wanted* copper is now removed and the surface sprayed with paint. When the paint is dry the rest of the plastic is removed, leaving the circuit painted on the board. The board is now etched, leaving the copper under the paint.

An important feature of the technique lies in the manner in which the plastic is cut to form the required printed circuit pattern. According to the type of tool employed, circular holes at component connecting points are made in the adhesive plastic either before or after it is applied to the board. Copper strips will be required in the pattern to join the component connecting points, and the

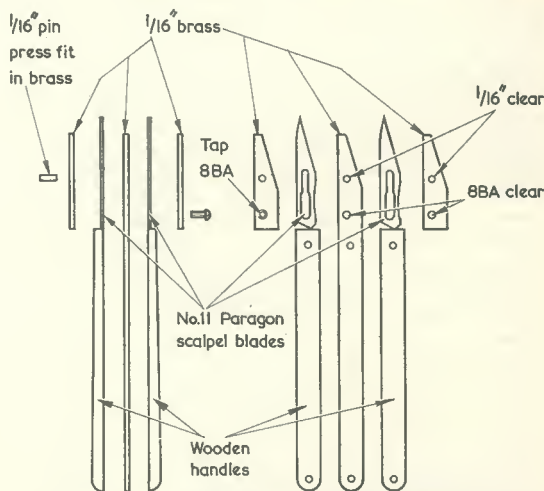

A suggested method of making up the double-bladed knife. It is important that the blades be rigidly secured close to their points, and it may in some cases be necessary to add further strengthening to an assembly of the type shown here

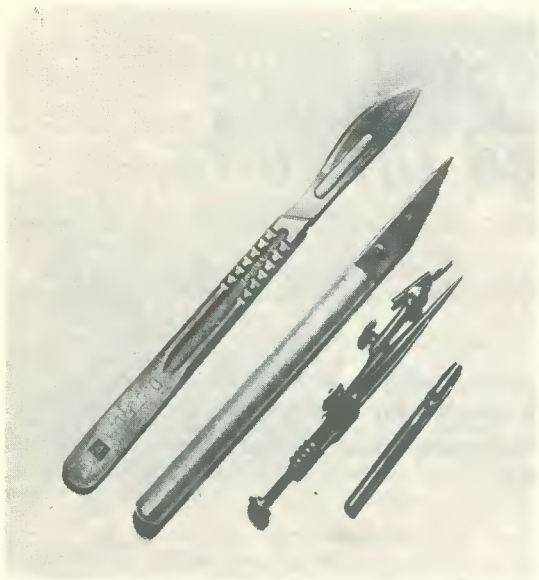

The tools employed by the author for the preparation of printed circuits. The instrument next to the compass is a home-made leather punch

corresponding sections of the plastic are cut by passing a double-bladed knife over it.

Tools

The main cutting tools that will be needed are a double-bladed knife and a device for cutting circles.

The double-bladed knife will be described first, and a suggested basic construction is given in the accompanying diagram. It consists simply of two blades mounted side by side with a spacer between them equal to the width of the copper tracks required. Many variations are possible on the construction shown in the drawing. It is important that the blades be rigidly supported close to the cutting edges or it will be difficult to cut parallel tracks with it. Best results should be given when the blades are supported to within $\frac{1}{8}$ in of the points. The No. 11 "Paragon" scalpel blades referred to in the diagram should be obtainable from shops selling surgical goods. But it is possible to design and make up a suitable double-bladed knife with other blades, such as those used in modeller's knives.

Two methods of cutting circles are available, each having its own advantages. A drop bow compass with a cutter replacing the lead or pen may be employed, and with this device circles down to about $\frac{1}{16}$ in diameter may be cut. The compass can be adjusted over a wide range, only one circle-cutting tool is required, and the point marks the centre for drilling. To offset these advantages, its cost is of the order of 30s., and greater skill is needed in its use than with the alternative method.

A cheaper circle cutter may be had in the form of

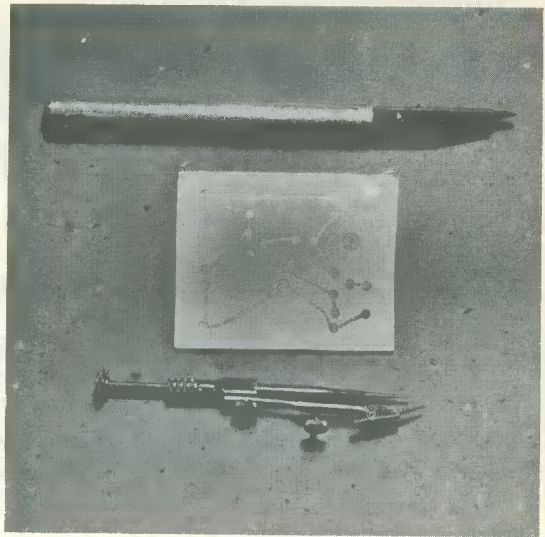

The tracks cut between the holes in the "Fablon". The large hole was made with the drop bow compass, and the tracks with the double-bladed knife. These two tools are shown also

a leather punch. These punches may consist of a single punch used with a hammer, or of the "multiplier" type. Punches are easier to use and produce a better hole, but several are needed if varied work is to be undertaken. Leather punches can be purchased from good tool shops. The accompanying photograph shows a home-made punch.

Procedure

The procedure used in making up a printed circuit differs according to the type of circle cutter used. The leather punch method will be described first. A piece of white adhesive plastic such as "Fablon" is cut to the size and shape of the copper laminated board, and the circuit pattern is drawn out on its surface. A hole of the required diameter is then punched out where each component is to be connected. The backing of the now-perforated plastic is removed, and the adhesive side of the plastic pressed down on the copper of the board.

The double-bladed knife is next employed to cut the tracks between the holes, after which these strips are peeled away. We now have the copper exposed in the shape of the circuit. It only remains to spray the whole surface with paint, peel the rest of the plastic off when the paint is dry, and etch.

If a drop bow compass is used to cut the holes for the lands, the plastic is attached to the board first and the holes then made. After this, the procedure continues as before.

It may be thought that if the plastic covering the wanted copper were left, and the surplus removed before etching, the painting operation could

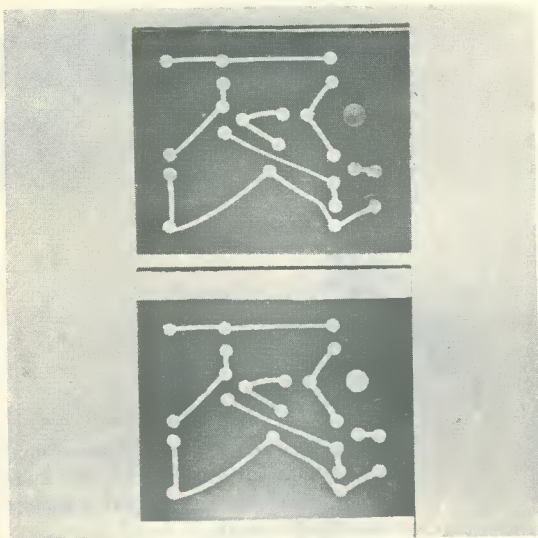

Two circuits completed from the same cutting

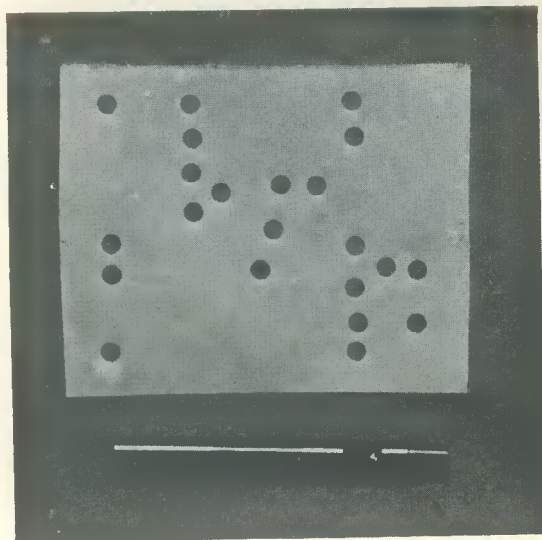

A piece of "Fablon" with holes punched prior to sticking on the board. The punch is also shown

be eliminated. This is in fact true, but the result is inferior due to seepage under the plastic. Also, if holes are cut with a drop bow compass a track will be cut across the copper, and etching will take place at this point.

The writer has found that Holt's matt black paint, in an aerosol, has been satisfactory when used as a resist with the process. Good results have also been given with Holt's grey primer.

Duplicating Circuits

The system may be extended to provide more than one circuit from the original cutting, but some skill is required if this is to be done successfully.

The duplicating process is carried out in the following manner. The first board is sprayed with resist and allowed to dry, the pieces of plastic covering the wanted copper being left in place. A second piece of adhesive plastic is then stuck on, taking care not to press it on to the painted

copper. This last requirement may be achieved by pressing down with a roller or flat surface. Both layers of plastic are then peeled off together, the uppermost plastic supporting the lower. The two layers are next pressed on to another board and the top plastic only peeled off. The second board is now sprayed with paint, and etched as before.

Another possible way of saving time when making several of the same circuit is to take a number of pieces of plastic equal to the number of circuits to be made, draw the circuit on one, and place this on top of the stack. All the pieces of plastic may then be punched together. The tracks are cut individually after sticking to the boards.

When making more than one printed circuit, it is desirable to use a plastic which does not stretch. In this respect, it may be found that "Fablon" is suitable when cold, but gives rise to difficulties during hot weather.



RADIO TOPICS

continued from page 539

controller which were calibrated in terms of distance off the glide path. These meters had centre-zero calibration, the centre point corresponding to correct positioning of the aircraft. The needle of one meter indicated distance of the aircraft off the glide path in azimuth (i.e. horizontal bearing) and the other indicated distance of the aircraft off the glide path in elevation. When both meters were at zero

the aircraft was exactly on the correct path. The controller was on the air all the time during the actual "talk-down", and continually passed on to the pilot the information given by these two meters so that the pilot could, when necessary, correct his course.

I spent days racking my brains to fathom out what the electronic circuits were which enabled the position of the aircraft to be so clearly presented on those two meters. When I enquired about it, I was cruelly disillusioned to learn that the meters were just coupled

to two manually controlled potentiometers. The operator on the azimuth display unit merely adjusted one of the pots to agree with the azimuth indication on his tube, and the operator on the elevation display unit similarly adjusted the other pot to agree with the elevation indication on *his* tube!

I must hasten to add that this occurred quite a few years ago, and that more sophisticated gadgets may very possibly be used in present-day G.C.A. installations.



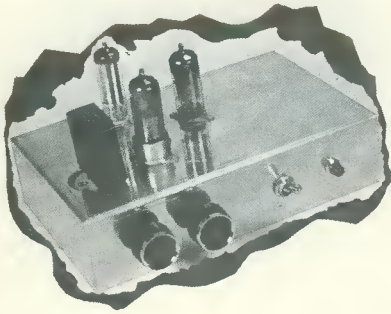

100-1000 Kc STANDARD

*
EF80

*
EF80

The frequency standard described in this article is an inexpensive ex-G.P.O. double-crystal unit. The 1,000 kc/s fundamental frequency standard stage has a stabilised h.t. supply and a balanced circuit for the fundamental and harmonic oscillation. The output is available at least

A FREQUENCY STANDARD HAVING A HIGH ORDER of accuracy is often required by the constructor, the experimenter and the short wave listener of serious intent. Such a unit will serve a useful purpose many times over in the workshop with the calibration of receivers and test equipment such as signal generators and grid-dip oscillators, etc. Indeed, without such a frequency standard, it is well nigh impossible to complete such tasks with any great degree of accuracy. Transmitter carrier frequencies can also be checked to the required accuracy limits by means of this unit.

With the aid of this frequency standard unit, a newly constructed communications receiver or r.f. signal generator can be accurately calibrated at each 100 kc/s point throughout the various frequency ranges, with the additional bonus of double-calibration at each 1,000 kc/s (1Mc/s) point. In this manner, the greatest stumbling block to both receiver and test equipment construction—that of really accurate calibration—is completely overcome. Usually, the constructor is advised to “calibrate against known stations and frequencies” but, in practice, the writer has found that this is never an easy nor a practical solution to the problem.

The Crystal Oscillator

The simplest method of obtaining a stable spot frequency source is, of course, to use a quartz

crystal. Such a crystal is piezo-electric whereupon, when an electric potential appears across it, the crystal is slightly deformed. A mechanical resonance can be set up in the quartz with a corresponding alternating electrical voltage evident across the two faces, and this mechanical resonance can be continuously maintained by means of a valve in a circuit such as that shown in Fig. 1. The quartz

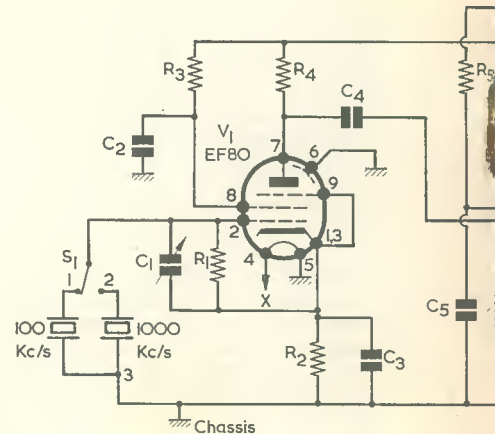

Fig. 1. Circuit of the C



Cover Feature

100 kc/s CRYSTAL FREQUENCY STANDARD

EF183

150C2

This article is unusual in that a relatively low frequency unit is employed, giving either 100 kc/s or 32 Mc/s at the turn of a switch. The oscillator and buffer-amplifier section ensures that both frequencies are audible at good strength up to at least 32 Mc/s

The crystal is similar in operation to an LC circuit, but the quartz resonant frequency is dependent on its physical dimensions. Due to this dependence, a greater frequency stability results from the use of a crystal than is available from a tuned circuit.

Oscillator Stage

The oscillator stage in the present unit includes an

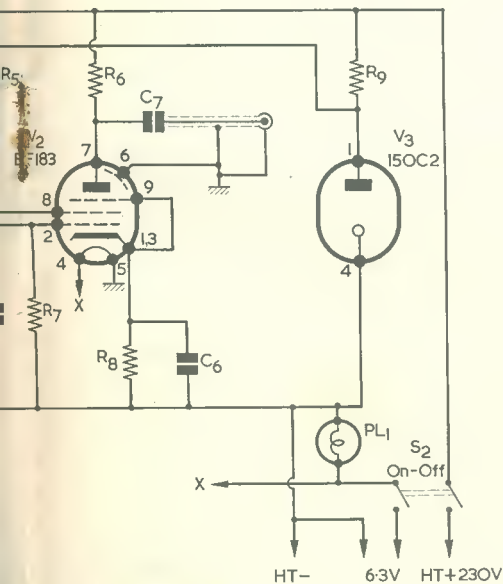

Crystal Frequency Standard

COMPONENTS

Resistors

(All 5% $\frac{1}{4}$ watt unless otherwise specified)

R ₁	470k Ω
R ₂	10k Ω
R ₃	82k Ω
R ₄	22k Ω
R ₅	82k Ω
R ₆	22k Ω
R ₇	100k Ω
R ₈	200 Ω
R ₉	4.7k Ω 4 watts

Crystal

100/1,000 kc/s (Henry's Radio Ltd.)

Chassis

8 $\frac{1}{2}$ x 5 $\frac{1}{2}$ x 2 in. (H. L. Smith & Co. Ltd.)

PL₁ Panel Lamp

L.E.S. 6.5V, 0.15A (H. L. Smith & Co. Ltd.)

Knobs

2 off (H. L. Smith & Co. Ltd.)

Capacitors

(All fixed values 350V wkg. unless otherwise specified)

C ₁	25pF variable, type C804, (Jackson Bros.)
C ₂	0.1 tubular
C ₃	0.001 μ F ceramic, 150V wkg.
C ₄	100pF ceramic
C ₅	0.1 μ F tubular
C ₆	0.01 μ F tubular, 150V wkg.
C ₇	0.001 μ F ceramic

Valves

V ₁	EF80 Mullard
V ₂	EF183 Mullard
V ₃	150C2 Mullard

Valveholders

2 off	B9A
1 off	B7G
1 off	5 pin UX ceramic

Switches

S ₁	Single-pole, 2-way, wafer
S ₂	Double-pole, single-throw on/off toggle switch, (Bulgin type S300)

Tagstrip

7-way, 3 tags earthed (H. L. Smith & Co. Ltd.)

By

FRANK A. BALDWIN

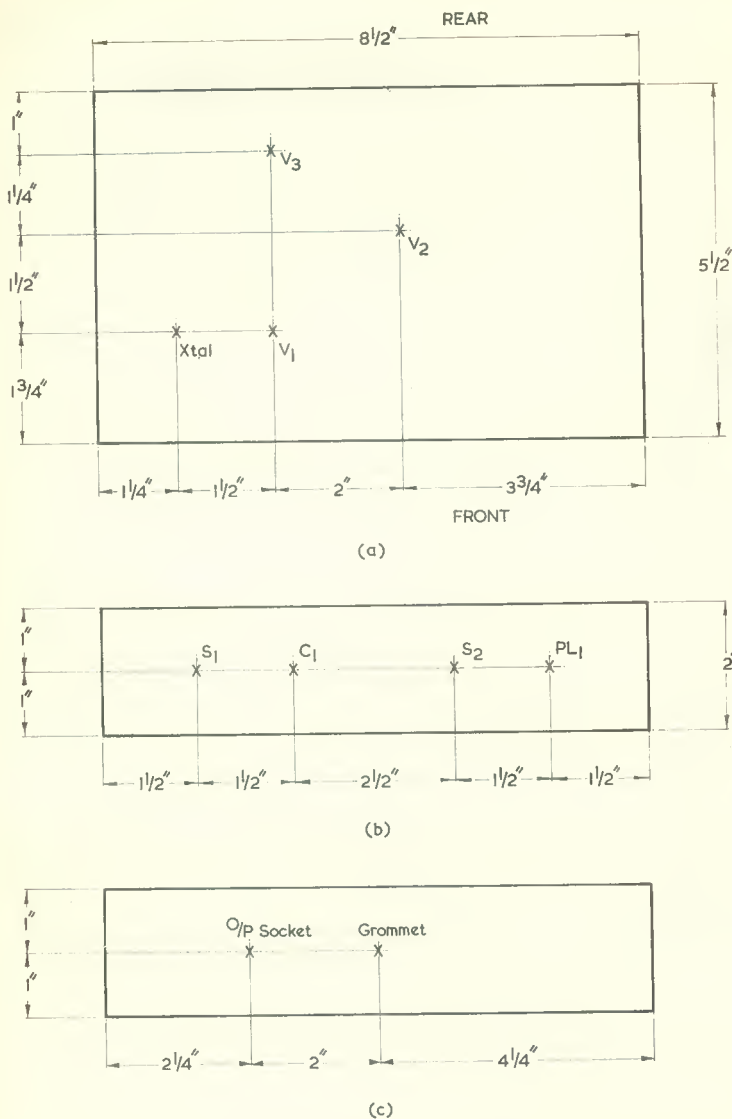

Fig. 2 (a). Chassis deck drilling measurements, (b) front apron and (c) rear apron

EF80 high slope r.f. pentode. When switch S_1 is in position 1, the 100 kc/s crystal is brought into circuit. The fundamental frequency of 100 kc/s is maintained by the crystal to extremely fine limits, but slight variation is possible by adjusting the variable capacitor C_1 , which alters its operating conditions. Capacitor C_1 is adjusted to make the oscillator frequency correspond exactly with a transmitted standard, as is described later under "Calibration". With S_1 in position 2, the 1,000 kc/s crystal is brought into circuit, causing marker "pips" to be heard at 1 Mc/s points when calibrating a communications receiver.

The circuit of V_1 will produce lots of harmonics, the output of this stage producing multiples of the fundamental 100 kc/s frequency beyond the 300th multiple. In more general terms this means that the oscillator stage will produce marker "pips" from the fundamental frequency of 100 kc/s up to over 30 Mc/s—in the writer's case to 32 Mc/s, the maximum tuning frequency in the receiver employed for checking—and the stage is therefore said to be rich in harmonics.

The circuit and component values around V_1 are such that the required harmonics appear at the anode, the necessary frequency control being given by the crystal in the grid circuit.

A stabilised h.t. voltage is supplied to this stage by the inclusion of a 150C2 voltage stabiliser tube (V_3), thus ensuring that variations in the applied mains voltage will not affect the correct operation of the oscillator stage and that the frequency stability of this stage is maintained as accurately as possible.

Buffer-Amplifier Stage

In the circuit of V_2 , an EF183 frame-grid r.f. pentode, component values are such that the stage will amplify both the fundamental frequencies and the harmonics generated by V_1 . These are presented to the grid of V_2 via the coupling capacitor C_4 . The output of V_2 is taken from the anode via C_7 and a short length of coaxial cable to the output socket of the unit. The inclusion of V_2 not only ensures that amplification of the marker points or "pips" occurs but also that no damping or "pulling" effects are given, as could be the case if the output of V_1 were connected (via the normal coupling capacitor) direct to an external unit under-going calibration. V_2 provides complete isolation

between the oscillator and the equipment to which the unit connects.

Power Supply

The power supply for the unit is taken from an external power pack and fed to the circuit via a double-pole, single throw, toggle switch mounted (as are all the controls) on the front apron of the chassis. See the illustration on the front cover. One pole of the switch (S_2) carries the h.t. potential whilst the other carries the heater supply. The panel lamp assembly, PL₁, provides a visible indication that the unit is switched on.

In the writer's case, the unit is connected permanently to the power supply via an octal plug and socket and, as the power supply is also used for other external equipment, it is necessary to include switch S_2 . The switch and/or the panel lamp assembly could be omitted where a separate power supply is used having its own switching arrangements, etc. Alternatively, of course, a small integral power supply could be included on the present chassis, space being available for this purpose as may be seen from the illustrations and from Fig. 2.

The power requirements are 200 to 250 volts h.t. at some 35 to 40 mA, together with a heater supply of 6.3 volts at 0.75 amps. The latter current becomes 0.6 amps if PL_1 is omitted.

Construction

As mentioned above, the chassis size allows for the inclusion of additional components, such as those for an integral power supply. The writer's present intention is to use this space for the later addition of a 10 kc/s multivibrator capable of being locked to the 100 kc/s oscillator. If none of these alternatives are required by the reader, the chassis could, of course, have smaller physical dimensions than those shown in Fig. 2.

The first point to be noted about the construction of this unit is that the crystal holder employed is, in fact, a 5-pin ceramic UX base, two pins of which are not used. As oriented on the chassis, pin 2 of the crystal (see Fig. 3) is nearest the valvoholder for V_1 . Fig. 3 shows a view of the crystal assembly looking at the underside with the pins pointing towards the reader, thereby identifying the pins.

The next point of note is that the variable capacitor C_1 , although mounted on the chassis front apron, must not make contact with the metal chassis at any point. It is common practice to use a 3-30pF concentric trimmer mounted under the chassis for the function carried out by C_1 , but the writer prefers the present arrangement because it enables full control of the unit to be provided without delving into the "innards" whilst switched on and in operation. To ensure that C_1 does not make contact with the chassis, it is necessary to fit the appropriate hole with a $\frac{3}{8}$ inch rubber grommet through which the shank of the spindle is fitted, the whole assembly then being secured in the normal manner by means of the securing nut. Despite the extreme simplicity of the insulated mounting thereby obtained, the capacitor is held firmly and reliably.

It will be noted from the underside view of the chassis that the switch fitted in the S_1 position in the prototype is in fact a 4-pole, 2-way switch, whilst the Components List specifies a single-pole type. The switch used was to hand at the time of construction and that stated in the Components List should be obtained where an alternative is not available. Fig. 4 shows the connections required.

A 7-way tagstrip with 3 tags earthed has been used for the various connection points in the prototype, this tagstrip being cut from a "chain" of tags. Other alternative methods of connection and component

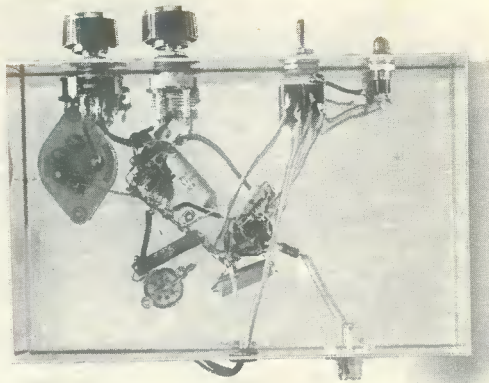

Below-chassis view showing the method of construction and the position of the 7-way tagstrip

mounting will no doubt occur to constructors of this unit.

Fig. 2 shows the drilling measurements of the unit (a) being the chassis deck, (b) the chassis front apron and (c) the chassis rear apron. The power supply lead is fed through the rubber grommet on the rear chassis apron and the output of the unit is taken from the coaxial socket contained on the same apron.

Wiring-up should present few problems. All component lead-outs and wiring carrying r.f. should be kept short, following normal short-wave practice. Component layout is eased if V_1 and V_2 valvoholders are both oriented so that pin 3 is nearest the front chassis apron.

Components

The components used in this unit should be of the highest quality if the maximum stability of operation is to be achieved. To this end the writer has specified all resistors as 5% tolerance. The capacitors likewise should be of good quality. In the prototype the tubular capacitors were Mullard polyester.

Calibration

The calibration of this unit is an extremely simple matter. All that is required is a receiver capable of being tuned to one of the WWV (National Bureau of Standards, Washington, D.C.) or MSF (National

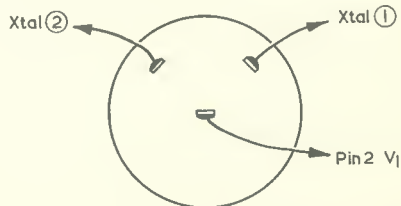

Fig. 4. Wiring details of the single-pole, two-way wafer switch, S_1

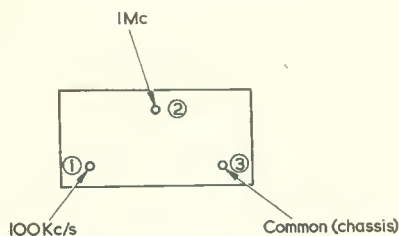

Fig 3. Base of the double-crystal unit with the pins pointing directly at the reader

Physical Laboratory, Teddington, Middlesex) standard radio frequency transmissions.* For practical purposes, in this country at least, the MSF transmissions on either 2,500 kc/s (2.5 Mc/s); 5,000 kc/s (5 Mc/s) or 10,000 kc/s (10 Mc/s) can be used as the standard. MSF transmits carrier and modulation frequencies within 2 parts in 10^8 of nominal on these channels.

If a crystal filter or Q multiplier is fitted to the receiver this should be switched into circuit to eliminate the "spread" of the transmissions and to ensure accurate frequency alignment of the oscillator.

Switch on the crystal standard, allow to warm up for 15 minutes to ensure absolute freedom from frequency drift (normal with most test equipment) and carefully adjust C_1 until the oscillator frequency harmonic exactly coincides with the standard to give zero-beat. It will be helpful here if the unit is placed some feet away from the receiver with a short insulated wire connected to the coaxial output socket of the crystal standard, this being wrapped around the receiver aerial lead several times in order to provide a coupling to the receiver input circuit. Should the receiver have a coaxial aerial input lead, the output wire will require to be connected to the aerial input of the receiver, or coupled via a low-value capacitor.

In the first instance, it will be found more convenient to calibrate the unit against the 5,000 kc/s (5 Mc/s) MSF transmission, since both the 100 kc/s

* Full details of these transmissions are contained in the *Radio Amateur Operator's Handbook*, published by Data Publications, Ltd.

and the 1,000 kc/s crystals can be switched into circuit and checked at this same frequency. This procedure may be followed by checking the crystal unit against MSF at 10 Mc/s and WWV at either 15, 20 or 30 Mc/s, both crystals being checked at the same time.

For those with uncalibrated communication receivers but who have access to a broadcast receiver, the 200 kc/s long-wave Light Programme transmission of the B.B.C. may be used, this being one of the most accurate frequency stability maintained stations in the world. Care should be exercised to ensure that exact resonance is obtained. The 200 kc/s transmission can only be used for the 100 kc/s crystal, however, the 5 Mc/s MSF transmission will eventually have to be located on the communications receiver (by means of the 100 kc/s marker points now available) for the 1,000 kc/s crystal to be checked. It was found that a correct setting for C_1 with the 100 kc/s crystal also held good for the 1,000 kc/s crystal.

Once C_1 is set correctly, there will be no need to readjust this control unless use is made of the standard in widely different temperature conditions, *i.e.* during the warm-up period or in an unheated outdoor workshop during winter conditions.

For initial test purposes a voltage Table is shown here. The voltage figures given should be looked upon only as a guide, as small variations are possible due to differing h.t. voltages and spreads in valve characteristics, etc. The prototype unit drew an h.t. current of 34mA at 235 volts.

TABLE			
V_1 pin 8	80V	pin 7	100V
V_2 pin 8	30V	pin 7	135V

As an accurate frequency standard, this unit has proved over a period of time to be reliable and stable. The hermetically sealed crystal unit itself is, as befits G.P.O. standards, a high-quality first grade component and its reasonable cost (25/-) should not deter constructors from obtaining this double-frequency assembly. The UX 5-pin base is also available from the same source as the crystal—see Components List. 

Arabian State Orders First Broadcasting System

Qatar, one of the wealthy oil states in the Arabian Gulf, has started to establish its first broadcasting station. The project was put to international tender, and the contract, worth approximately £200,000 has been won by The Marconi Company. They have already started to supply the equipment, and it is anticipated that transmissions will begin early next year.

A powerful 100kW short wave transmitter will be used to provide a coverage over a 1,200 miles radius, and for local broadcasting this will be supplemented by a 10kW medium wave transmitter. Both these transmitters, broadcasting identical programmes, will be installed in a broadcasting station a few miles outside Doha, the capital of Qatar. The station will be connected by links to a Marconi equipped Studio Centre, situated in Doha itself.

The installation is one of a series of comprehensive modernisation projects which were initiated by the Government of Qatar a number of years ago. The object is to promote the living standards and prosperity of the Qatar people and to this end, economic, social, cultural and administrative improvements are being made.

Qatar will be the tenth country in the Middle East using Marconi broadcasting equipment.

IN LAST MONTH'S ISSUE, WE CONCLUDED OUR examination of the pentode valve, showing how it may be employed for r.f. and a.f. amplification. We now revert to constructional matters and will demonstrate what we have discussed by adding an r.f. pentode stage to the 3-stage long, medium and short wave receiver described in the issues for November and December 1966, and for January 1967.

Modified Reaction Circuit

The 3-stage receiver so far constructed consists of a triode grid leak detector with reaction, a triode a.f. voltage amplifier and a beam tetrode output valve. A slight difficulty with the design was that some trouble was experienced in obtaining "smooth" reaction for all aerials likely to be encountered. The reaction circuit finally employed gave good results but introduced the disadvantage that the detector triode anode voltage tended to be low at some reaction control settings, with the consequence that a.f. gain was reduced.

this nature cannot offer the same results and ease of tuning as are given by a superhet receiver. Even with the additional r.f. stage which is now introduced there are still only two tuned circuits to select the desired signal, whereas a conventional valve superhet has at least five. Nevertheless, the performance offered by the set with its added r.f. stage is quite impressive for this class of receiver. With careful adjustment of the reaction control, selectivity on medium and long waves approaches that of a superhet, and there is more than adequate volume for domestic listening.

The revised circuit appears in Fig. 1 and this may, if desired, be compared with the circuit of the receiver, as described to date, which appeared in the November 1966 issue. No change is made to the output stage in which the 6BW6 (V_2) appeared, and the output stage wiring is not included in the circuit diagram given in Fig. 1.

It will be helpful, first, to examine the modified reaction circuit. Previously, feedback from the anode of $V_{1(a)}$ to the reaction winding of coil L_1

UNDERSTANDING RADIO

Adding An R.F. Stage

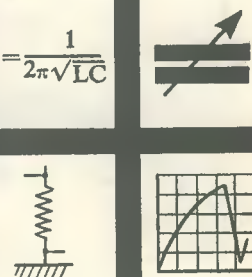
$$f = \frac{1}{2\pi\sqrt{LC}}$$

by W. G. Morley

Problems with reaction are very much eased when an r.f. amplifier stage precedes the detector because the detector coil is fed from the constant impedance offered by the anode of the r.f. valve. It then becomes possible to employ a reaction circuit which offers best results without the problems introduced by varying aerial impedances.

The modified receiver, therefore, incorporates an altered reaction circuit as well as the additional r.f. stage. The 25k Ω potentiometer used for reaction control is now replaced by a variable capacitor, the potentiometer being removed to the r.f. stage where it functions as an r.f. gain control. Several of the previous resistors and capacitors are replaced by new values, and a few new components are added to the detector and a.f. amplifier stages. The new reaction circuit enables the detector triode to offer a high level of a.f. amplification at all settings, whereupon the receiver offers an overall gain, both at radio and audio frequencies, which is more than adequate for entertainment listening.

It must be again emphasised that a receiver of

was made via a fixed capacitor, the reaction control consisting of a potentiometer which varied the h.t. voltage applied to $V_{1(a)}$ anode. In the present version the positive h.t. supply is fed to the anode of $V_{1(a)}$ via the fixed resistors R_3 , R_{16} and R_{17} , the degree of feedback being controlled by the new reaction control, C_{18} . R_3 is retained from the previous circuit, whilst R_{16} and R_{17} are new. R_3 and electrolytic capacitor C_{19} form an a.f. decoupling filter in the same manner as did R_3 and C_4 in the preceding circuit. C_4 was specified as 150V wkg., whereas the present circuit requires a working voltage of at least 300. If the constructor happened to fit a capacitor with a working voltage of 300 or more in the previous version, this may be retained, as C_{19} , in the present circuit. The same applies to C_{21} which replaces C_6 , the latter capacitor being similarly specified as 150V wkg.

Also in the anode circuit of $V_{1(a)}$ is the new capacitor C_{20} . This provides a low reactance path for r.f. signals whilst offering a high reactance at audio frequencies.

With the addition of the r.f. stage and the modified

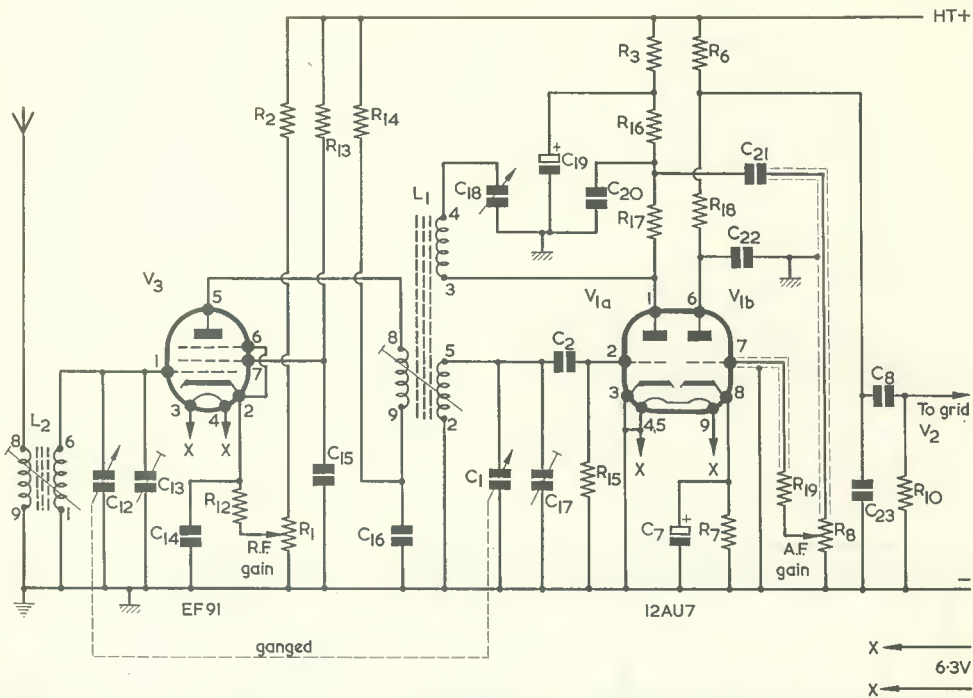

Fig. 1. The circuit of the modified receiver, excluding the output stage which is unaltered. The added r.f. stage incorporates an EF91 pentode

reaction circuit, the overall amplification offered by the receiver is considerably enhanced, and steps have to be taken to prevent unsatisfactory operation when the reaction control is advanced to the setting which offers maximum sensitivity. In particular, care is needed to prevent interaction between the a.f. and r.f. stages on the long waveband where the lowest radio frequency, at 150 kc/s, is only 10 times the highest audio frequency of 15 kc/s. Since $V_{1(b)}$ is in the same envelope as $V_{1(a)}$, some capacitive coupling exists between the two valves, and the r.f. signal handled by $V_{1(a)}$ can also appear at the anode of $V_{1(b)}$. Any r.f. signal at the anode of $V_{1(b)}$ is bypassed to chassis by the filter formed by the components C_{22} , R_{18} and C_{23} . A further filter is provided by the new resistor, R_{19} , which is inserted in series with the slider of a.f. gain control R_8 and the screened lead to $V_{1(b)}$ grid. The complete filter here is given by R_{19} and the self-capacitance between inner and outer conductors in the screened cable plus the capacitance between grid and cathode in the valve itself. Fig. 2 shows how these "hidden" capacitances appear, in conjunction with R_{19} .

It should be mentioned that the new components just referred to have been added mainly to enable satisfactory reaction to be achieved on the long waveband. Without them, the presence of oscillation as the reaction control is advanced is indicated by a howl instead of the desired hissing noise. On

medium and short waves, where the radio frequencies are considerably higher than audio frequencies, it is not necessary to provide as much r.f. filtering to achieve satisfactory reaction.

Also added to the detector stage is the trimmer C_{17} , which connects across the tuned circuit. This is needed because we now have two tuned circuits controlled by a 2-gang capacitor, and it is necessary to provide an adjustment which assists in keeping them both at the same resonant frequency as the capacitor is rotated. The final modification, in the interests of good reaction with the new circuit, is a change in grid leak value to $2.7M\Omega$. This is provided by R_{15} . The old grid leak (R_2) is re-used in the r.f. stage.

The R.F. Stage

We may now turn our attention to the r.f. stage, which incorporates an r.f. pentode (V_3) type EF91. The aerial is applied to the coupling winding (pins 8 and 9) of L_2 , the tuned winding (pins 1 and 6) being tuned by trimmer C_{13} and variable capacitor C_{12} . C_{12} , with C_1 , forms the 2-gang tuning capacitor. It will be recalled that C_1 was originally specified as either a single-gang capacitor or one section of a 2-gang capacitor if the constructor intended to add the r.f. stage. C_{12} is the section of the 2-gang capacitor which has previously been unused.

The signal selected by the tuned winding of L_2 with C_{12} and C_{13} is applied to the control grid of

Components Already Fitted

Resistors

- R₁ 25kΩ potentiometer, carbon track, linear (was reaction control)
- R₂ 1MΩ (was V_{1(a)} grid leak)
- R₃ 75kΩ 1 watt
- R₆ 100kΩ ¼ watt
- R₇ 3kΩ ¼ watt
- R₈ 250kΩ potentiometer, carbon track, log
- R₁₀ 470kΩ ¼ watt

Capacitors

- C₁ See C₁₂, below
- C₂ 100pF, silver mica
- C₇ 12μF, electrolytic, 6V wkg.
- C₈ 0.01μF, paper or plastic foil

Inductor

- L₁ Miniature Dual Purpose Coil, Green, Ranges 1, 2 and 4, as required (Denco)

Valve

- V₁ 12AU7 or ECC82

New Components

Resistors

(All ¼ watt 10% unless otherwise stated)

- R₁₂ 300Ω 5%
- R₁₃ 15kΩ
- R₁₄ 4.7kΩ
- R₁₅ 2.7MΩ
- R₁₆ 220kΩ
- R₁₇ 47kΩ
- R₁₈ 15kΩ
- R₁₉ 47kΩ

Capacitors

- (All fixed values 300V wkg. unless otherwise stated. 0.047μF may be used in place of 0.05μF)
- C₁₂ (With C₁) 310pF, 2-gang, E-gang variable capacitor, Cat. No. 4507. (Jackson Bros. Ltd.)
- C₁₃ 25pF, variable capacitor, Type C.804. (Jackson Bros. Ltd.)
- C₁₄ 0.05μF, paper or plastic foil, 30V wkg.

- C₁₅ 0.05μF, paper or plastic foil
- C₁₆ 0.05μF, paper or plastic foil
- C₁₇ 50pF, mica trimmer, "postage stamp" type
- C₁₈ 50pF, variable capacitor, Type C.804. (Jackson Bros. Ltd.)
- C₁₉ 2μF, electrolytic (see text)
- C₂₀ 300pF, ceramic
- C₂₁ 0.01μF, paper or plastic foil (see text)
- C₂₂ 300pF, ceramic
- C₂₃ 1,000pF, ceramic

Inductor

- L₂ Miniature Dual Purpose Coil, Blue, Ranges 1, 2 and 4, as required (Denco)

Valve

- V₃ EF91

Sockets

- 1 B7G valveholder with centre spigot
- 1 B9A valveholder with centre spigot

Screws, Nuts

- 11 6BA cheese- or binder-head screws, ¼in
- 11 6BA nuts
- 2 ¾in washers (see text)

Miscellaneous

- 1 Knob type K402, black (Bulgin). Cat. No. KN77 (Home Radio (Mitcham) Ltd.)
- 1 Pointer knob
- 1 Spindle extender, Cat. No. DL52B (Home Radio (Mitcham) Ltd.)
- 3 6BA solder tags
- 2 Angle brackets (see text)
- Connecting wire, solder, etc.

Lektrokit Chassis Parts

- (All Lektrokit parts are available from Home Radio (Mitcham) Ltd. The 5-way tagstrip and lead-through insulators are supplied in quantities of 10 or 12, and may already be available from those previously obtained.)
- 1 Chassis Plate No. 1. Part No. LK-111
- 1 Tagstrip, 5-way. Part No. LK-2231
- 2 Insulators, lead-through, No. 1. Part No. LK-2021

V₃. The cathode of this valve is bypassed for r.f. by C₁₄ and a variable cathode voltage is made available by means of R₁. When the slider of R₁ is at the bottom end of its track the cathode is biased by the voltage dropped across R₁₂, and V₃ offers maximum gain. As the slider of R₁ is moved upwards a continually increasing positive voltage is applied to the cathode until, with the slider at the top of the track, the valve becomes virtually cut off. Thus, R₁ provides a control of r.f. gain. The resistor R₂, between the upper end of R₁ and the h.t. positive line, ensures that R₁ can provide sufficient cathode bias to cut off the valve. Without R₂ the current flowing in R₁ would be that due to the valve alone, whereupon it would

be impossible to take the valve beyond cut off. The screen-grid of V₃ is supplied by the usual series resistor, R₁₃, and is bypassed by C₁₅. The suppressor grid is brought out to a separate pin, and is coupled externally to the cathode.

The anode connects to pin 8 of the coupling winding of L₁, this being the pin to which the aerial was previously connected. Before the addition of the r.f. stage, pin 9 of the coupling winding is connected to chassis. This direct connection is now replaced by C₁₆, which has a low reactance at r.f., whilst pin 9 couples to the h.t. positive line via R₁₄. Thus, the anode current for V₃ flows through the coupling winding, with R₁₄ and C₁₆ functioning as decoupling components.

COMPONENTS

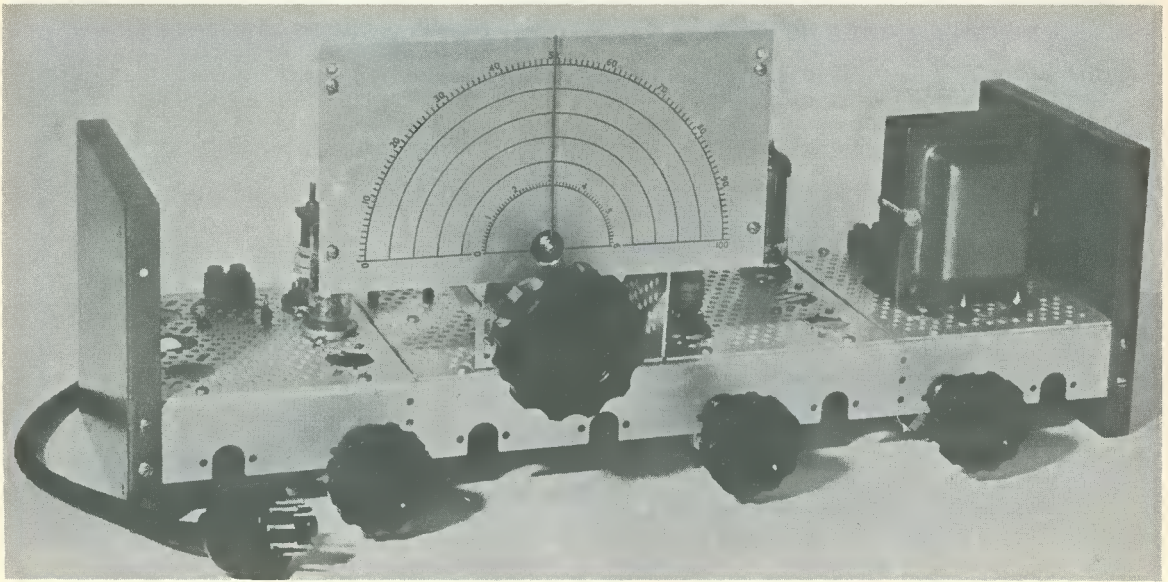

Front view of the modified receiver. Note the additional r.f. gain control at the left

When two separate coils are tuned by a 2-gang capacitor they should "track" accurately (i.e. both have the desired resonant frequency) at all settings of the capacitor. As we have seen earlier,* tracking with iron-cored coils may be achieved by adjusting parallel trimmers at the high frequency end of the band covered, and the positions of the cores at the low frequency end. The first process is known as *trimming* and the second as *padding*. The present circuit uses plug-in coils whose cores may be individually adjusted, and it then becomes possible to adjust the core of each coil to the required position for good tracking at the low frequency ends of the bands they cover. This state of affairs does not, however, allow for trimming of individual coils at the high frequency ends of the bands. It was felt that the best approach towards trimming with the present receiver would be to use a preset trimmer in the detector tuned circuit, and a knob-operated trimmer in the aerial tuned circuit. In Fig. 1, these trimmers are C_{17} and C_{13} respectively.

* In "Understanding Radio" in the April 1963 issue.

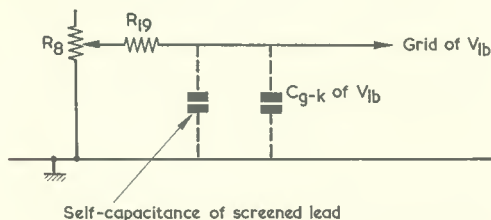

Fig. 2. R_{19} forms a low-pass filter in conjunction with the self-capacitance of the screened lead to $V_{1(b)}$ and the capacitance between $V_{1(b)}$ grid and cathode

C_{13} is a small variable capacitor fitted to the rear Chassis Rail, and is capable of adjustment by means of a knob fitted to its spindle. When one set of coils is removed and another range plugged in, C_{13} may then be adjusted for optimum trimming on the new range. In practice, this approach presents little inconvenience. If the receiver is mainly employed for entertainment listening on medium and long waves, C_{13} need only be set up for best results on medium waves, its position then being sufficiently close to the optimum for long waves to enable satisfactory reception to be obtained. Thus, changing from medium to long waves, and vice versa, consists merely of changing the coils. For short wave reception, the readjustment of C_{13} for optimum results can be carried out in a few seconds.

Practical Points

The accompanying Components List first gives details of the components in Fig. 1 that are already fitted. These components are listed for convenience whilst examining Fig. 1. A further list under the heading "New Components" then gives details of the new parts which have to be obtained for the modification of the receiver. It will be noted that three new r.f. coils are specified, these being Denco Blue coils to match the Denco Green coils already obtained for the L_1 position.

Also listed under "New Components" are two $\frac{3}{16}$ in washers. These washers are required to enable the bushes of C_{13} and C_{18} to be mounted in the appropriate U-slots of the Lektrokit Chassis Rails. The washers may be of the shake-proof variety which are normally supplied with new potentiometers and similar components, and it may possibly be found that suitable spare washers are available from those supplied with R_1 and R_8 .

The knob type K402 matches the two small knobs already fitted, whilst the "pointer knob" may be any small knob having an engraved line to indicate its setting. This knob is fitted to C₁₃.

The spindle extender is fitted to the spindle of C₁₈ and enables its knob to be in the same plane as the other knobs at the front.

Also specified are a Lektrokitt Chassis Plate No. 1 and two angle brackets. The Chassis Plate functions as a screen between the two coils and it is mounted vertically between V₁ and the 2-gang capacitor, being held in place by the angle brackets. No specification or dimensions are given for these brackets and they may be made up from an odd piece of aluminium or similar material. Due to the large number of available holes in the Chassis Plates to which the brackets are bolted, it should in many cases be possible to find two suitable small brackets in the constructor's spares box.

First Constructional Steps

The first constructional steps consist of the modification of the reaction circuit. In the step-by-step instructions which follow, it is assumed that the points concerning soldering, etc., which were given in the earlier articles will be automatically followed. One new matter which arises here is that some components have to be disconnected from their solder tags. If the component leads were originally "clinched" tightly to the tags before soldering, it will often be found easier to remove them by cutting the lead-out wires close to the solder joint than to attempt to untwist the wire with a soldering iron applied. The latter process may cause damage to other components connected to the tag. All connections referred to are soldered when they are made.

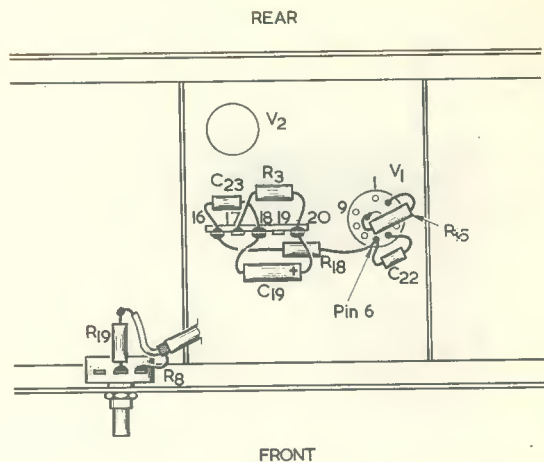
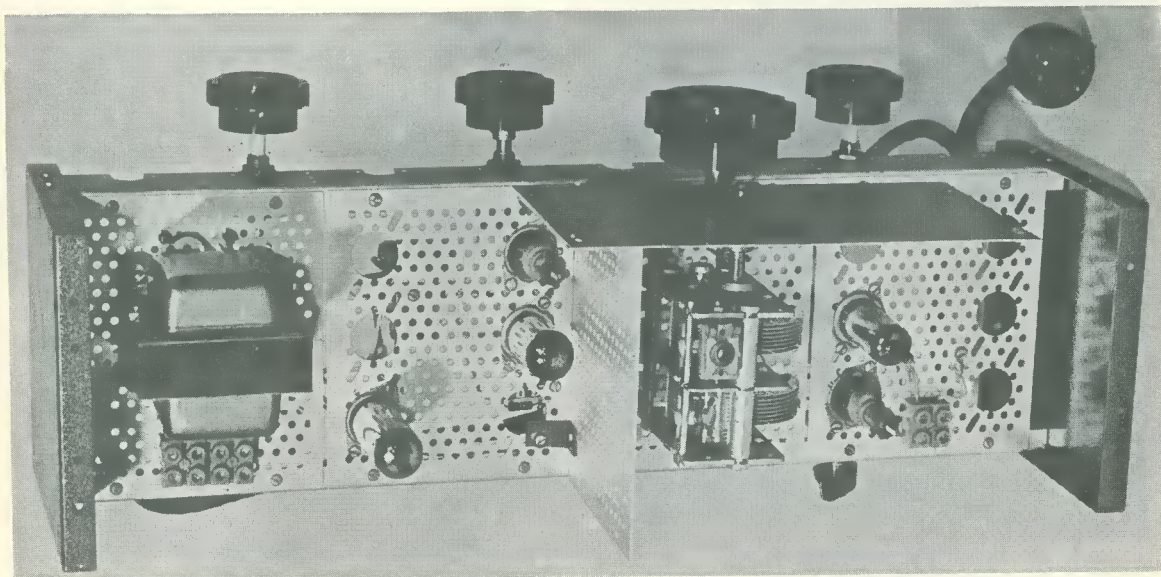

Fig. 3. First steps in wiring the modified receiver

1. Put the chassis on its side so that it stands vertically on the Side Plate at the output transformer end. The underside of the chassis should be towards the reader. The steps which follow are illustrated in Fig. 3.

2. Disconnect the screened lead centre conductor which connects to the centre tag of potentiometer R₈. Solder one end of R₁₉ to the centre tag of the potentiometer, and to the other end of R₁₉ solder the screened lead centre conductor which has just been disconnected.

3. Unsolder (at the potentiometer tags only) the two wires and the resistor (R₃) which connect to the reaction control potentiometer R₁. Remove
(continued on page 560)



Top view, illustrating the positions taken up by the new coil and valve, and the vertical screen fitted between V₁ and the 2-gang tuning capacitor. The spindle and knob of C₁₃ are visible at the rear

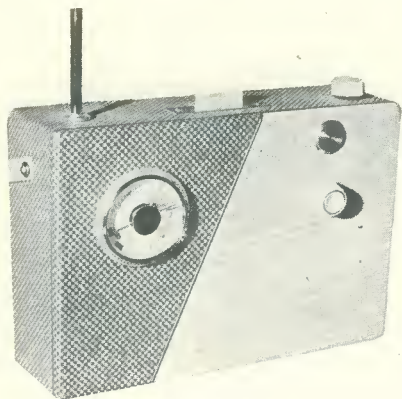

High Sensitivity Transistor VHF Portable

PART 2

by T. Snowball

THE MAIN CONSTRUCTIONAL INFORMATION required is, of course, that for the coil details, and the bulk of this will be found in Fig. 3.

The construction of the coils should be as accurate as possible or some of the tuning capacitors may have to be changed slightly in order to make the core tune correctly. For instance if, in the i.f. transformers, the constructor finds that the cores of either primary or secondary need to protrude right through the coil, then the author recommends that either more capacitance or more turns be added, because this condition will upset the coupling between the coils. In the case of the r.f. coils, inaccurate construction will cause no ill effects other than perhaps a change of tuning capacitor or some confusion while setting up. Enamelled copper wire is used for all coils.

Notes on Individual Coils

L_1 is wound self-supporting, and compressing or extending the coils will enable a considerable range of coarse tuning to be carried out. Use an insulated stick at least 4in long for adjustment.

L_3 is best wound as tightly as possible on the former and should not be doped until the oscillator frequency has been set up and the constructor is quite sure that the oscillator is covering the right range of frequencies. A coat of dope to hold the coil secure may then be applied. The original Mullard design (see Reference 1 in February issue) specified a self-supporting coil, but the author has found that sound vibrations cause the coil to vibrate with resultant audio feedback (microphony) when the receiver is housed in the same cabinet as the loudspeaker, and so final doping is necessary.

With IFT₁, IFT₂ and IFT₃, the spacing between the coils is the most critical part of the construction, and the author recommends the following procedure.

Wind on the primary complete and with the correct number of turns, then lightly dope. Closer to the primary than the correct spacing, wind on at least 10 secondary turns, and lightly dope. When

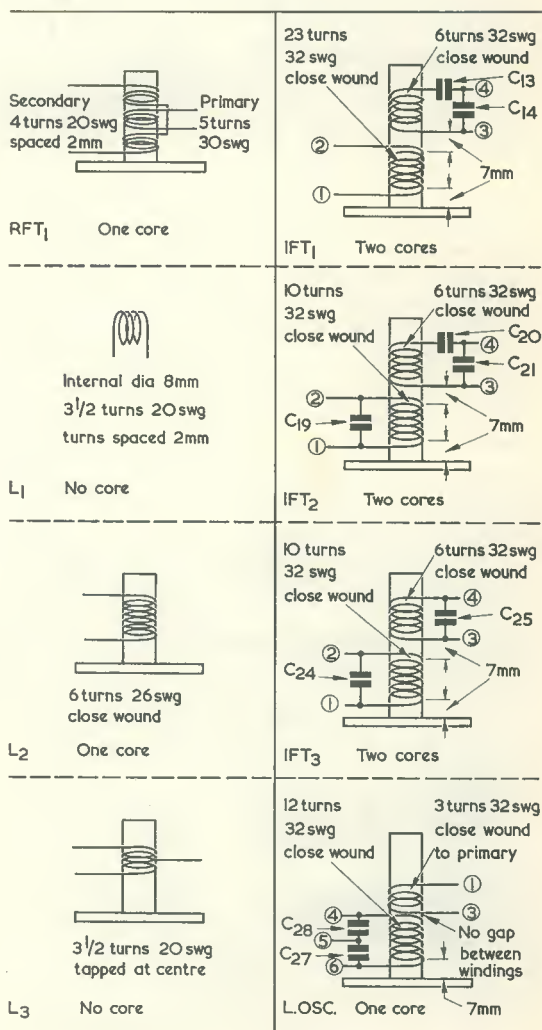

Fig. 3. Details of the coils and i.f. transformers. All wire used is enamelled copper

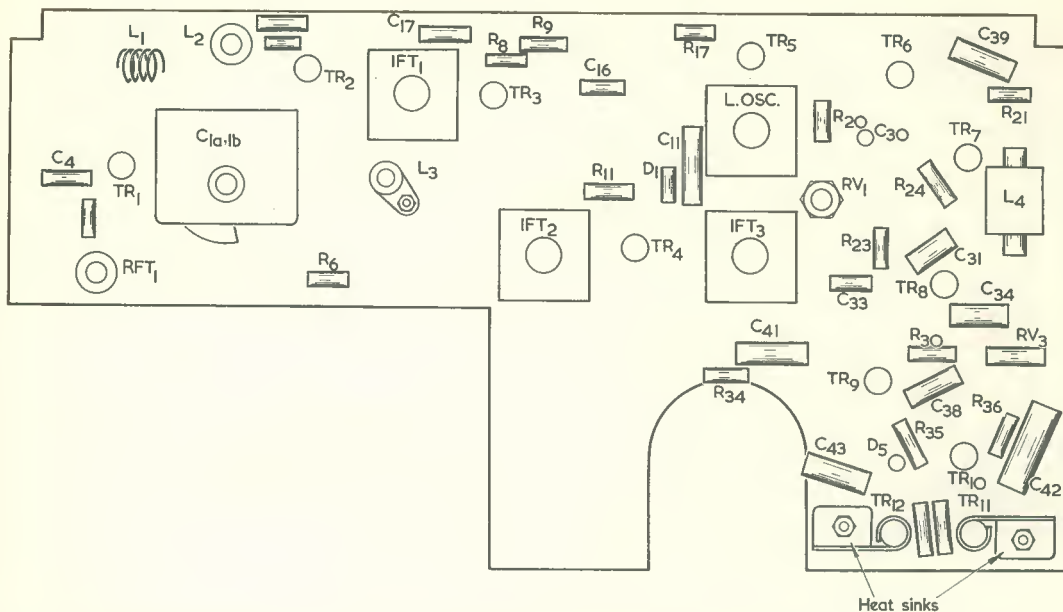

Fig. 4. The positions taken up by the major components on the copper side of the board. Transistors TR₃ to TR₁₀ pass through holes in the board with their leads on the underside, whilst TR₁₁ and TR₁₂ are on heat sinks above the board, being connected into circuit by very short wiring

all is dry unwind the secondary from the centre until the correct spacing (7mm) is given. Then wind off more turns from the outer end, until the correct number of turns (6 turns) is obtained, whereupon another coat of dope finishes the job. There is zero spacing between the two windings of L_{osc}.

The author included the tuning capacitors C₁₃, C₁₄, C₁₉, C₂₀, C₂₁, C₂₄, C₂₅, C₂₇ and C₂₈ within the coil cans. Five leadout wires are needed with L_{osc} and the coil formers employed here should be of the type which has six lead-out eyelets or lugs.

Layout

The author feels that a layout which approaches the way the circuit is drawn is quite suitable with, of course, short wires, and especially in the TR₁ and TR₂ stages. The length of lead from TR₂ collector to the tap on L₃ via C₁₀ must be as short as possible. The wiring to TC₁ must also be as short as possible. The layout used by the author for the main components is given in Figs. 4 and 5, and this enables very short wiring, particularly in the r.f. and i.f. stages to be obtained. A detailed diagram showing the r.f. components is given in Fig. 6.

The chassis construction used by the author consisted of employing a standard printed circuit board with the copper side to the front, on which the tuning capacitor is mounted. The copper is unbroken and chassis connections are made, where required, by soldering to the copper at the nearest

point. This method of construction is recommended, at least for the r.f. stages, because of the good earth it provides. Connections through the board are made with insulating lead-throughs such as those employed in the Lektrokit prefabricated chassis system.

If the constructor employs the cabinet used by the author (see the Components List in Part 1) the board may be made up to the dimensions shown in Fig. 7. In this diagram, the non-copper side of the board is towards the reader. With this cabinet, also, it will be necessary to mark out a new tuning scale to replace the medium/long wave scale provided. A simple dial pointer, which springs on

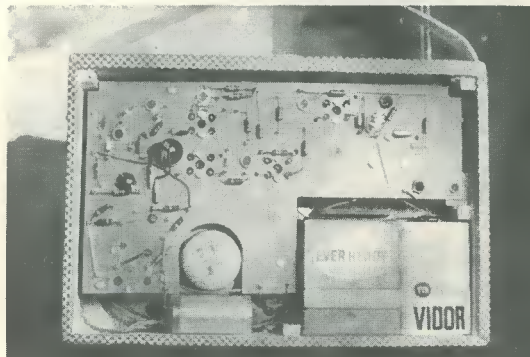

The rear side of the board, mounted into the cabinet. RV₃ and RV₄ were not fitted when these photographs were taken

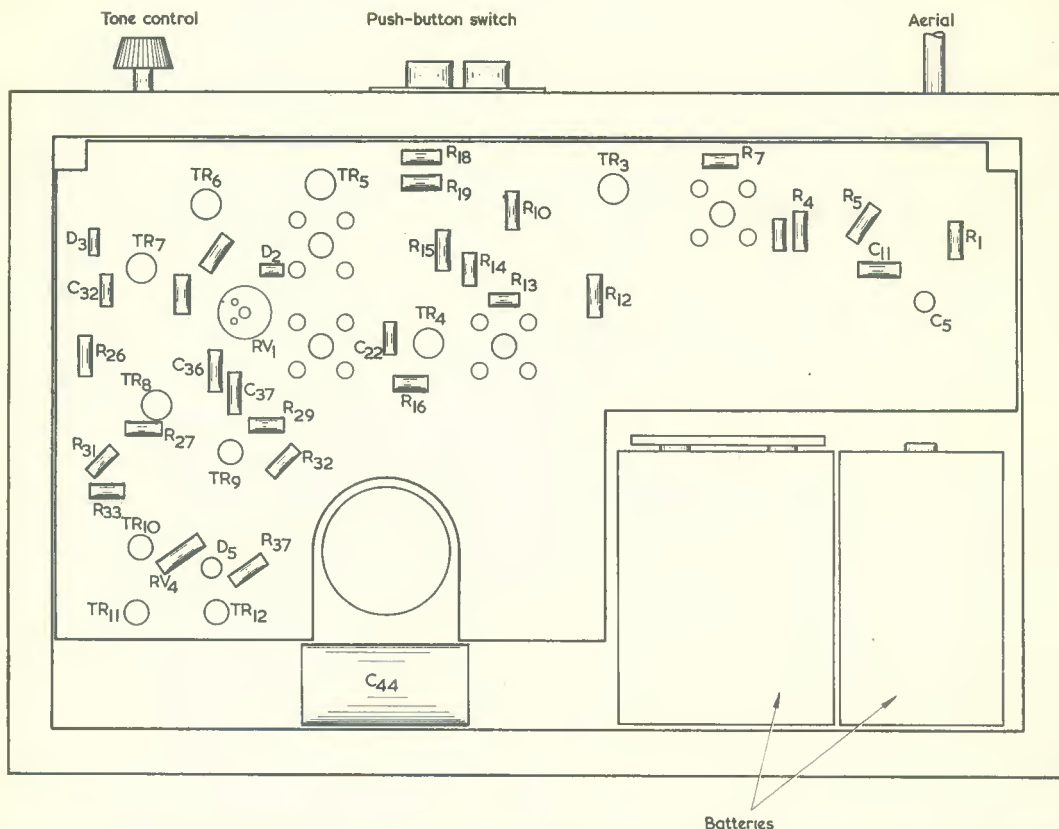

Fig. 5. The positions of the major components on the non-copper side of the board, illustrating also how the board fits into the cabinet. The telescopic aerial is between the board and the cabinet front panel, as also are the tone control and the push-button switch

to the 1:1 shaft of the tuning capacitor spindle, may be made from 16 s.w.g. wire as shown in Fig. 8.

The printed circuit board is supported on three blocks of wood glued to the inside of the cabinet, woodscrews passing through the board into these blocks. It may be necessary to extend the spindle of the volume control by adding a shaft extender. The tone control is fitted to the top panel of the cabinet, as shown in the photograph. The push-button assembly provided with the cabinet quoted in the Components List has two buttons and was originally intended for medium/long wave switching. A slight pressure on either button causes both to cancel.

Setting-Up Instructions

The art of getting a good receiver is, of course, bound up with the correct setting-up of each stage. Some of the steps which are now to be described may seem rather simple, but the more experienced constructors should still not ignore them.

When first switching on, insert a meter in each supply lead. If the current does not exceed 30mA from the positive supply and 20mA from the negative supply, then it should be in order to continue stage by stage setting-up.

The Output Stage

Two main setting-up points apply here. Firstly, the junction of R₃₈ and R₃₉ should be set at OV by means of RV₃. Secondly, the quiescent current in TR₁₁ and TR₁₂ should be set to at least 3mA by means of RV₄. As was mentioned last month, more than 3mA may be necessary with some unbalanced transistors. The correct current is not very critical, and can be found by listening at low volume or by using an oscilloscope with a sine wave applied across RV₁. The oscilloscope is coupled to the junction of R₃₈ and R₃₉. Fig 9 (a) shows crossover distortion due to too low a quiescent current while Fig 9 (b) shows correct operation. The actual measurement of quiescent current is carried out most easily by having a meter reading overall battery current; if RV₄ and D₅ are then short-circuited, the change in meter reading is the quiescent current in the output transistors.

If an audio signal generator and oscilloscope are available, a check of frequency response from RV₁ to the output should show it to be within 3dB from 80 c/s to 12 kc/s. However, the upper and lower limits of frequency response can easily be changed if the receiver is feeding a loudspeaker

system which is capable of using a greater frequency response. C_{40} controls the top cut off point, while C_{36} , C_{37} , C_{41} , C_{43} and C_{44} need larger values to get down to 50 c/s.

Voltage measurements should be as follows:

TR ₉ base	+1.7V
TR ₉ collector	+8.4V
TR ₁₀ emitter	+8.7V
TR ₁₀ collector	+0.2V
TR ₁₂ base	-0.2

Also, voltage readings across components in the a.f. section should be as follows:

R ₃₃	0.5V
R ₃₅	1.5V
R ₃₆	0.35V
R ₃₇	9V
C ₃₈	8V
C ₃₉	8V

Diode/Transistor Pump Circuit

No setting-up is required here, but check voltages under the following conditions:

No signal and, C_{32} disconnected,
 TR₈ collector -7.5V
 TR₈ emitter 0V

Second i.f. Stages

Check that the collector voltage of TR₇, with no signal or noise input and with C_{30} disconnected, is between -3.5V and -6.5V, if not, correct by adjustment of R₂₂.

The following voltages should be given:

TR ₇ collector	-5V
TR ₇ emitter	-1.0V
TR ₆ base	-0.2V
TR ₆ collector	-1.2V

First i.f. Stages

Reconnect C_{30} , and short-circuit R₁₈ to stop the second oscillator, which may cause confusing results. Take R₈ off the junction with R₁₀ and join R₈ to 4.7k Ω resistor connected to the +8V supply line. This now frees D₁ and its associated components and allows them to be used as a signal monitor during alignment. The author used an AVO 8 on the 50 μ A range across C_{16} , but almost any other meter, with at least 250 μ A as its most sensitive scale, can be used instead.

Disconnect C_7 from its junction with TR₁ collector, and use this as a 10.7 Mc/s injection point. Disconnect one end of C_8 because, since it forms part of a 10.7 Mc/s rejection circuit, it will upset the i.f. strip alignment.

The cores of IFT₁, IFT₂ and the primary of IFT₃ can now be adjusted for maximum signal at 10.7 Mc/s, keeping the reading on the meter below 100 μ A, and bearing in mind the earlier note on core position. To tune IFT₃ secondary connect the meter across R₂₀; the reason for not using R₂₀ most of the time is that when the second oscillator is working, a large reading will be obtained from L_{osc} thus obscuring the i.f. signal.

Check that the bandwidth is at least 200 kc/s. If the reader is unlucky and the i.f. strip oscillates,

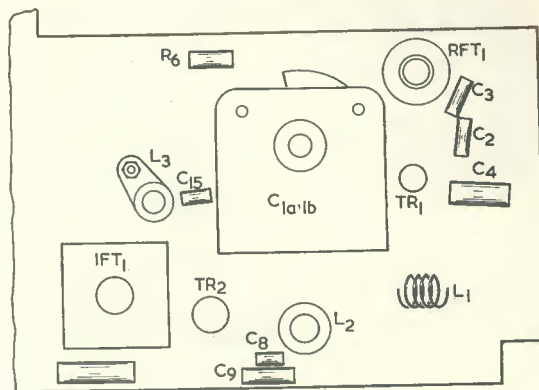

Fig. 6. Component positioning in the r.f. stage

then extra damping resistors of 18k Ω can be connected across one or more of the i.f. transformer windings, but this should be extremely unlikely and is caused by bad layout. However, the point is not excessively critical; extra damping will only lead to some loss of gain and the bandwidth will probably still be useable.

The following voltage readings should be given:

Across R ₁₅	1.5V
Across R ₁₄	1.7V
Across R ₉	1.6V
TR ₄ collector	0V
TR ₃ collector	0V

Second Oscillator at 10.5 Mc/s

Remove the short-circuit across R₁₈, and a connect a meter across R₂₀. The current on an AVO8 switched to a current range was 150 μ A, thus indicating that the second oscillator was working. To adjust the oscillator to 10.5 Mc/s, connect an earphone across R₂₀ and inject a signal through C_7 as during alignment. Set the signal generator to

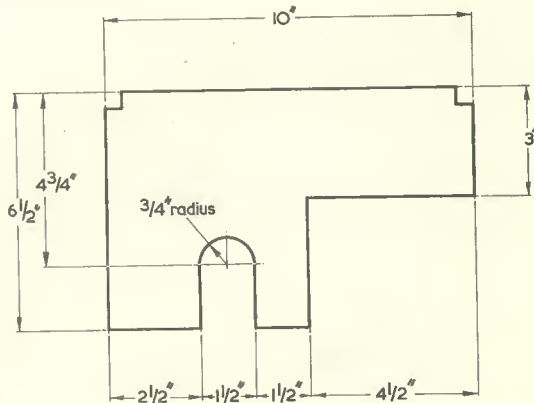
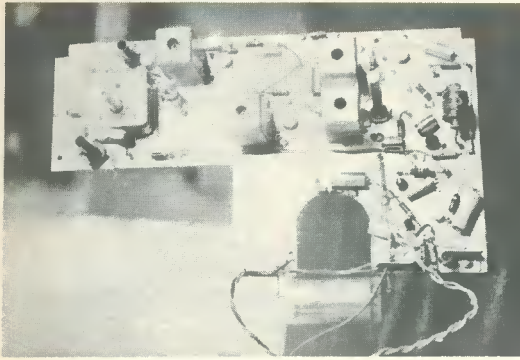

Fig. 7. Dimensions of the printed circuit board. The non-copper side is towards the reader. An alternative radius and width for the speaker aperture may be required with some loudspeakers



A view of the front side of the board

10.5 Mc/s and rotate the core of L_{osc} , whereupon a beat note will be heard as TR_5 oscillates at 10.5 Mc/s. Be sure to reduce the injected signal to a low level to avoid spurious responses.

This 10.5 Mc/s setting can be checked by removing the earphone, and injecting a 10.7 Mc/s signal through C_7 , and applying a voltmeter to TR_8 collector. The correct setting for IFT_4 core will correspond to a voltage on TR_8 collector between -3.5 and $-4.0V$, showing that a second i.f. of 200 kc/s is being produced and causing the earlier calculated collector current for TR_8 of 0.38mA to flow. Swinging the signal generator from 10.6 to 10.8 Mc/s should change TR_8 collector from about $-5.8V$ to $-1.5V$ respectively. These are calculated values using a supply line of $-8.0V$.

The signal generator should now be quietening the noise, which should otherwise be audible with no signal coming in. As a measure of sensitivity the noise should be suppressed from about 10.6 to 10.8 Mc/s for a signal input of about 5 to 10mV. But a warning must be given that this may vary considerably depending upon the signal generator used. If an oscilloscope is available check the waveform at TR_7 collector. This should be a square wave of about 7V peak-to-peak amplitude with rise and fall times of about $1\mu s$ and $2\mu s$ respectively, but be sure to use low capacitance probes and an oscilloscope of at least 1 Mc/s bandwidth.

The following voltage readings should be given:

Across R_{19} 2.3V
 TR_5 base $\pm 5.5V$
 TR_5 collector 0V

Reconnect C_8 and, with the signal generator at 10.7 Mc/s and using a current-reading meter across C_{16} as a monitor, tune L_2 for minimum

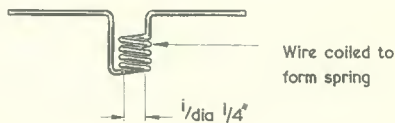

Fig. 8. A simple tuning scale pointer may be made up from 16 s.w.g. wire, as shown here

output. This sets up the 10.7 Mc/s series resonant trap L_2, C_8 . A point to remember is that this trap must be disconnected whenever the i.f. strip or receiver sensitivity is checked by injecting a signal at C_7 .

The RF and Mixer Stages

Reconnect C_7 to TR_1 collector, apply the signal generator to the aerial coil, and set TC_1 to mid-capacitance. Using the meter across C_{16} and the loudspeaker for monitoring, it should be possible to find out what frequency the receiver is tuned to; but remember to keep the input as low as gives a useable signal because spurious signals will quickly lead one astray.

As the r.f. stage is not very selective, a signal will be heard 10.7 Mc/s above and below the oscillator frequency. In this design the oscillator is intended to be at 97.7 Mc/s for the lowest received frequency of 87 Mc/s, with the second channel signal at 108.4 Mc/s. These factors enable the oscillator frequency to be found, and the first thing to do is to adjust C_1 fully in mesh so that the oscillator runs at 97.7 Mc/s, corresponding to a required signal frequency of 87 Mc/s. Then with C_1 fully out of mesh the received frequency should be about 108 Mc/s, but as most of the useful v.h.f. signals finish at about 97 Mc/s, do not worry if the oscillator does not go high enough to receive 108 Mc/s. In point of fact it helps the tracking of the r.f. stage to cover only the minimum needed, and in this respect C_{15} may be increased to reduce the oscillator swing. If loud rasping noises come from the loudspeaker at certain settings of the tuning capacitor this is probably due to the oscillator squegging, because of too much feedback via TC_1 . Reducing TC_1 should correct this trouble.

Having set the oscillator to the desired range, L_1 and C_6 next need to be adjusted to give correct tracking over the required frequency range. L_1 is airspaced so an insulated tool can be used to close or open its turns. As mentioned earlier, this should be at least 4in. in length. Starting at the low frequency end, adjust L_1 for maximum signal across C_{16} , then move up in frequency and see if the tracking is correct by once more compressing or extending L_1 . If it is found that L_1 needs to be compressed, corresponding to a rise in inductance, this indicates that $C_{1(a)}$ is changing too rapidly. The situation can be cured by increasing C_6 , which reduces the percentage change in capacitance for any fixed angle of rotation in $C_{1(a)}$. Increasing C_6 will, of course, necessitate retuning L_1 at the low frequency end (87 Mc/s) and starting from there again. Finally tracking should be such that tuning from 87 to 97 Mc/s, at the least, varies the current reading from C_{16} by only 50%.

The last job on the r.f. stage is to set the signal generator to about 92 Mc/s and tune RFT_1 core for a maximum. This will be very broad as this transformer should have a minimum bandwidth of 10 Mc/s. Nevertheless it is important to get the adjustment correct because it helps the rejection of 10 Mc/s short wave signals.

It may be necessary, in extreme cases, to vary C_3 to allow the core of RFT_1 to tune correctly.

The following voltage readings should now be obtained:

- Across $R_2 = 0.8V$
- Across $R_5 = 1.2V$
- Across $R_6 = 0.7V$
- TR_1 base $6.5V$
- TR_1 collector $0V$
- TR_2 base $6.0V$
- TR_2 collector $0V$

This completes the setting-up, but a final check on the core of RFT_1 when connected to the usual aerial and tuned to a station about 92 Mc/s.

Re-connect R_8 to R_{10} and ensure that a.g.c. operation is correct. Correct a.g.c. operation can be easily checked by monitoring the voltage drop across R_9 and R_2 . As the input signal at the aerial is increased the voltages across R_9 and R_2 should fall, indicating that the gain of TR_1 and TR_3 is being reduced by a.g.c. current from D_1 .

The receiver is then ready for use.

Automatic Frequency Control

Automatic frequency control can be used to ease the handling of the receiver in one of the following two manners:

With a tuning meter connected to TR_8 collector it can enable precise tuning to be obtained, whilst correcting for temperature or voltage drifts.

Alternatively by the use of an a.f.c./manual switch, it enables the receiver to be operated by most people without even the expense of a tuning meter. In this case switching to manual will enable even inexperienced persons to tune near enough to the desired position, whereupon the a.f.c. will then reduce any errors to sufficiently small proportions to obtain fully correct operation. The diode/transistor pump circuit will work correctly with at least 50 kc/s of tuning error.

The a.f.c. utilises the capacitance of a reverse biased diode. This capacitance reduces with increasing back voltage on the diode. If the diode is connected in parallel with the oscillator coil the voltage swings across this coil may forward-bias it on alternate half-cycle peaks; but by putting a capacitor in series with the diode the oscillator voltage is stepped down as, of course is the effective capacitance control offered by the diode. Nevertheless, it is still capable of satisfactorily changing the frequency of the oscillator.

In the a.f.c. circuit shown in Fig. 10, the resistor R_A is used to isolate the oscillator voltage from C_A , while R_B is used to decouple the audio at TR_8 collector from C_A . The result is that only the average d.c. level at TR_8 collector influences the diode D_A . This d.c. level is a measure of the second i.f. frequency as described earlier, so if the second i.f. rises due to drift, the voltage at TR_8 collector becomes less negative. This decreases the negative bias on D_A , increasing its capacitance and reducing the oscillator frequency. As the oscillator frequency is higher than the aerial frequency, this means that the first i.f. decreases by a small amount. Now the second

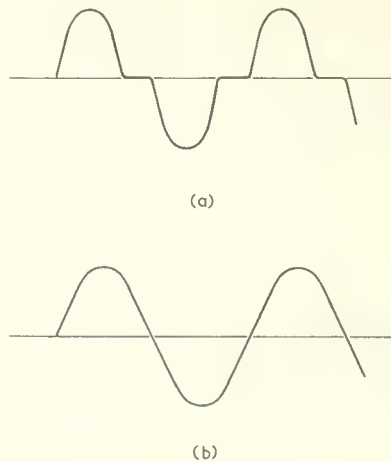

Fig. 9 (a). Cross-over distortion, resulting from too low a quiescent current in the output transistors
(b). The sine wave output given when no cross-over distortion exists

oscillator is at 10.5 Mc/s, which is lower than the first i.f., so the decrease in first i.f. frequency causes a decrease in second i.f. frequency. This counteracts the original rise and so completes the a.f.c. loop.

As can be seen from the typical curve shown in Fig. 11, the change of diode capacitance is more rapid near minimum bias voltage so, to get the maximum amount of control, it is obviously advantageous to work at low reverse bias. The components R_{28} C_{34} reduce the collector volts of TR_8 with this view in mind; incidentally they also give increased d.c. gain to TR_8 , but only to carrier frequency because C_{34} smooths out the audio signal. This enhanced d.c. gain increase the voltages change applied to D_A for any given amount of oscillator drift.

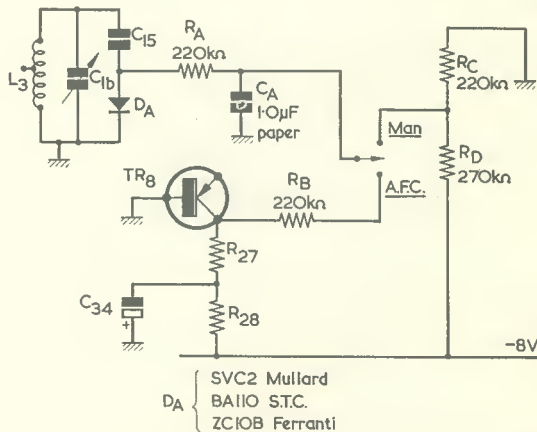

Fig. 10. An optional a.f.c. circuit which may be added to the receiver. The numbered components are those in Fig. 1 (published February)

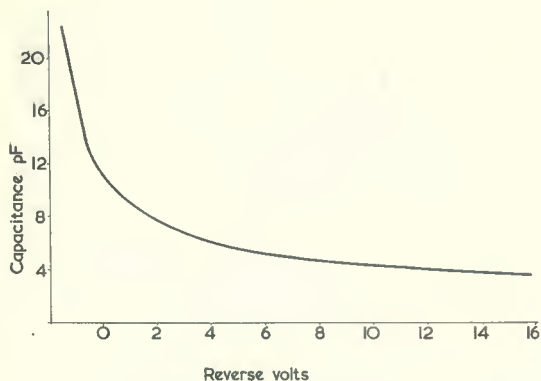

Fig. 11. A typical curve showing diode capacitance versus reverse voltage

The choice of diode for D_A is quite wide. Almost any diode will work, but the types which are especially produced as variable capacitance diodes are obviously best. If the reader decides to experiment, he should aim at using a high frequency silicon diode, although diodes such as the OA10, OA5 and OA70 will give some control. The author used a Mullard SVC2 which is now in the replacement category, so two other types are suggested in the drawing.

A.F.C. can cause a small side-effect which can be a little puzzling. Once the a.f.c. has locked on to a signal, it may hold the frequency of the oscillator steady as $C_{1(b)}$ is rotated beyond the next station. Then the a.f.c. will become unlocked, whereupon the tuning will jump past that next station. An a.f.c./manual switch is therefore recommended, as shown in Fig. 10. The two resistors R_C and R_D bias the diode D_A to the voltage that TR_8 collector should have when the receiver is correctly tuned (-3.5 to $-4.0V$), and this enables manual tuning to be carried out with the correct amount of diode capacitance in the circuit.

In the prototype, the push-button switch provided with the cabinet quoted in the Components List is employed to give a.f.c./manual switching. The left-hand button, when depressed, switches on the receiver and selects manual tuning. After a station has been tuned in, the right hand button may then be

depressed, if desired, to select a.f.c., the receiver being once again switched on.

A check of a.f.c. action consists of detuning the receiver on manual operation whilst monitoring the voltage on TR_8 collector; switching to a.f.c. should then cause the error to reduce. The amount of correction depends upon various factors such as the capacitance inserted by the tuning capacitor and the type of diode being used. In the author's case, the a.f.c. reduced the error by 75%.

Tuning Indicator

As has been previously mentioned, the collector of TR_8 is the correct point for application of a tuning indicator. This will usually take the form of a microammeter, either shunted to read the collector current of 0.38mA as a correct tuning point, or with a series resistor to read the collector voltage of -3.7 for correct tuning.

If a centre-zero meter is available, a potential divider across the 8V supply to give $-3.7V$ will enable the correct tuning point to correspond to zero current through the meter. The potential divider should consume about 0.5mA.

Home-Wound Chokes

As was stated previously, some readers may prefer to wind their own 1.5mH chokes for the L_4 position instead of obtaining this component ready-made.

Two types of construction may be employed. The first consists of winding 175 turns of 40 to 42 s.w.g. enamelled wire in a Neosid pot core type 10D/WR. The second consists of winding 65 turns of 26 to 30 s.w.g. enamelled wire in an LA1 Ferroxcube pot core. Either of these choke assemblies may be employed in place of that specified.

Conclusion

In conclusion the author hopes that the constructor will appreciate that the aim of the full description he has given is to help in understanding the details of design, and perhaps to lead to individual modification. The final receiver should be sensitive, interference-free and capable of high quality reproduction. Although it uses about three more transistors than a ratio detector type of receiver, it involves no complications of discriminator transformer design and it has a very linear discriminator characteristic. *

UNDERSTANDING RADIO

(continued from page 553)

this potentiometer. Remove the lead which previously connected the potentiometer to the chassis tag below it. Remove the lead which previously connected the potentiometer to tag 20. (See Fig. 3 for tag numbering.)

4. Unless the component already fitted has a working voltage of 300 or more, remove the $2\mu F$ electrolytic capacitor, C_4 , from tags 18 and 20. Replace with C_{19} , observing the same polarity.

5. Remove the wire which previously connected

pin 6 of V_1 to tag 16. In its place fit R_{18} , the body of which should be close to the underside of the chassis. Both lead-outs of R_{18} should be sleeved.

6. Connect the free end of R_3 (previously connected to R_1) to tag 20. For neatness, it may be desirable to shorten the other lead of R_3 .

7. Connect C_{23} between tags 16 and 18.

8. Connect C_{22} between pins 5 and 6 of V_1 .

9. Remove the existing $1M\Omega$ grid leak R_2 , fitted between pin 2 and the centre spigot of V_1 valveholder. Fit R_{15} in its place, keeping its lead-outs as short as possible. Retain R_2 for later use in the r.f. stage. *



Sound Operated Switch

By J. Roberts

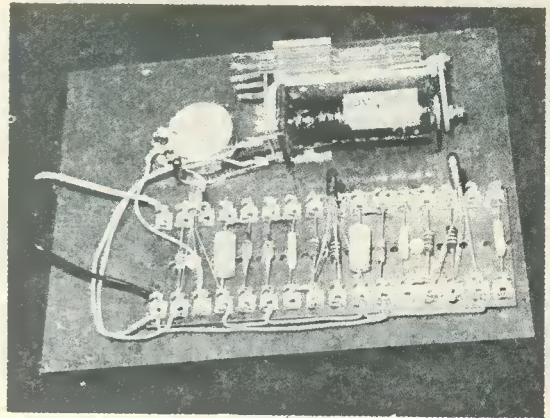

THE DEVICE TO BE DESCRIBED WILL SWITCH THE apparatus it controls on or off when a sound is made in its vicinity. The device was originally constructed for security applications but there are numerous other possible uses, these ranging from the conservation of recording tape to a voice-operated door scheme.

Transistors have been used for the usual advantages of small size and low power consumption. An effort has been made to reduce the number and cost of the components by using simple circuitry and components available on the surplus market. The high sensitivity requirement of the original application led to the use of a standard loudspeaker as the microphone, and the device was housed in the loudspeaker cabinet so that the completed unit appeared to be part of a loudspeaker system. If the size of the completed unit is important for a particular application, the circuit could be built far smaller than the original.

The sensitivity was found to be more than adequate for the original application. If required the sensitivity can be improved considerably by using a more sensitive relay than the P.O. Type 3000 specified and by properly matching the loudspeaker to T_1 , although it may probably be easier and cheaper for the home constructor to merely add another stage of amplification. The P.O. relay does have the advantages of availability, low cost and the ability to switch heavy loads. The sensitivity of the prototype, when a 10in loudspeaker was used as a microphone, was such that normal speech at a distance of around 15ft operated the relay. With a smaller loudspeaker, a 7 x 2in unit, sensitivity was considerably less, and the relay was operated by normal speech at 1½ft only. An exceptionally high sensitivity was given when a model control relay was used instead of that specified, the slightest sound in the vicinity of the speaker tripping the relay.

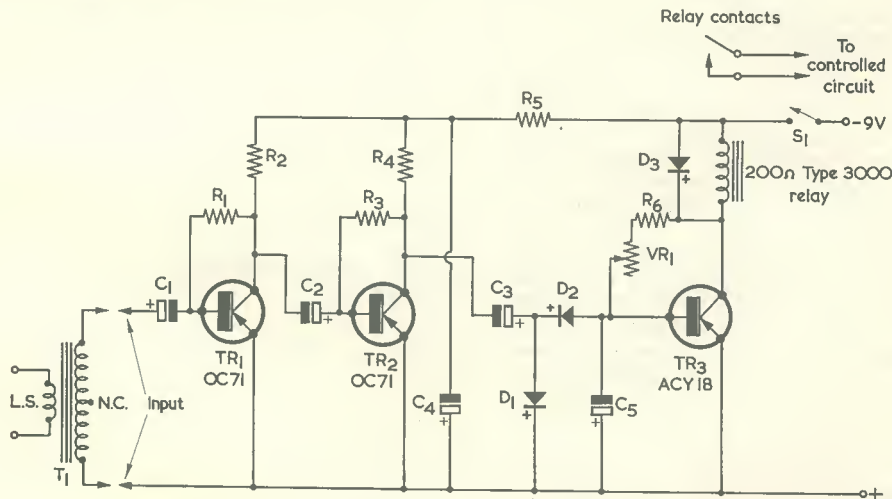

Fig. 1. The circuit of the sound operated switch. The loudspeaker connected to T_1 functions as a microphone. T_1 is a transistor output transformer with the primary connecting to the input of the amplifier

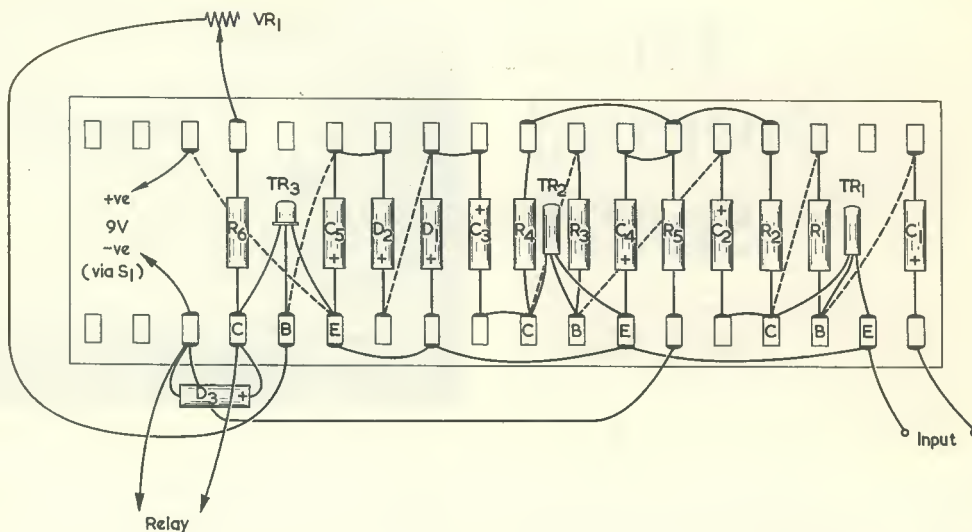

Fig. 2. The very neat layout of components on the groupboard is clearly demonstrated by this diagram

The Circuit

The circuit, which is shown in Fig. 1, uses three transistors; two are employed in conventional a.f. stages, and the third switches the relay. The a.f. output from the first two stages is rectified and applied to the base of the switching transistor. The potential on the base of the ACY18 then rises and falls with changes of the sound level, causing the relay to pull-in or drop-out accordingly.

It can be seen from the circuit that only an elementary approach towards achieving d.c. stability has been employed. In practice, however, the degree of stability obtained is quite adequate for operation at normal room temperatures.

The problem of coupling the loudspeaker to the first stage was overcome by using a standard transistor output transformer (Rex, LT700). This arrangement has been found to be quite successful and any similar low power component should prove to be satisfactory. The a.f. stages are conventional, but their frequency response can be limited or tuned to certain frequencies for particular application demands, should this be desired. The a.f. output from TR₂ is applied to a rectifying circuit of the diode pump variety. The d.c. output is then applied to the switching transistor, TR₃, which operates the relay. An ACY18 is specified for this position, but the OC72 is available cheaply on the surplus market and the writer has found this to be suitable also. It must be pointed out, however, that the OC72 is operated close to maximum rated dissipation in the circuit, and that constructors requiring a high degree of reliability should use the ACY18. An OC72 was fitted when the unit was photographed for this article. The diode connected across the relay coil is intended to protect TR₃ against the back e.m.f. induced during drop-out.

COMPONENTS

Resistors

(All fixed values $\frac{1}{4}$ watt, 10%)

- R₁ 220k Ω
- R₂ 4.7k Ω
- R₃ 220k Ω
- R₄ 2.2k Ω
- R₅ 470 Ω
- R₆ 47k Ω
- VR₁ 500k Ω potentiometer, linear track

Capacitors

- C_{1,2,3} 8 μ F electrolytic 15V wkg.
- C_{4,5} 100 μ F electrolytic 15V wkg.

Inductor

- T₁ Transistor output transformer type LT700 (Rex)

Semiconductors

- TR_{1,2} OC71
- TR₃ ACY18 (see text)
- D_{1,2,3} OA81

Relay

- P.O. type 3000 with 200 Ω coil (see text)

Switch

- S₁ s.p.s.t. on-off switch

Miscellaneous

- 3 Ω loudspeaker (to function as microphone)
- 9-volt battery
- 18-way groupboard

Construction

No attempt was made to make the device particularly small and it was constructed on a standard tagboard. The relay and variable resistor can be mounted on the rear of the tagboard if required. The usual precautions must be taken when soldering the transistors, diodes and small capacitors.

A completely different layout can, of course, be used, as the positioning of the components is not critical.

Adjustments

Resistor VR_1 will, for most applications, have to be adjusted (under no-signal conditions) so that the collector current of TR_3 is just below the drop-out

current of the relay. If desired, the current can be adjusted to be just below the pull-in value, so that the relay will remain pulled-in when the sound level falls after energising. The capacitor C_5 may be reduced in value if a faster response is required, and the limiting resistor R_6 adjusted to the requirements of different relays, if used. When a loudspeaker is employed as microphone it should be as large as possible for maximum sensitivity.

The current drawn from the supply by the first two stages is 2mA at all signal levels. TR_3 current is 38mA maximum on very large signal peaks, with a standing no-signal current (after adjustment of VR_1) of 6mA. 

IN YOUR WORKSHOP...

TRIUMPHANTLY, DICK CARRIED the dual-standard 23-inch TV receiver over to the "Repaired" racks.

With a surprised expression, Smithy turned round from the chassis which was lying on his bench.

"Blimey," he remarked shortly, "you were smart with that one, weren't you? You've only had it on the bench for ten minutes."

"There was nothing to it," replied Dick airily, as he carefully deposited the set in the racks. "Just an open-circuit screen-grid resistor in the vision i.f. strip, that's all. A little masterly diagnosis on my part of the receiver's symptoms, and I located it straightaway."

Smithy looked suitably impressed. "You certainly found it soon enough," he commented grudgingly. "It looks as though you're going to be a really top-line service engineer one of these days, after all."

Elated at this unaccustomed praise from Smithy, Dick turned his attention to the "For Repair" racks and successfully suppressed the small quail of conscience which suggested that he should, perhaps, have told the Serviceman a little more of the story. That screen-grid resistor had indeed been open-circuit; so open-circuit in fact that it had become a charred wreck which would have immediately caught the eye of the most myopic of engineers on taking off the back. It had taken only a moment to find that the 1,000pF screen-grid bypass capacitor to which it connected had broken down to present a firm and indisputable short-circuit, whereupon the reason for the resistor's demise had been

demonstrated beyond doubt and no further fault-finding was required. But who amongst us does not, on occasion, unashamedly take credit when credit is really due to an unexpected kindness from the Fates?

Volume Uncontrolled

The embryo Top-Line Service Engineer ran his eye over the receivers awaiting repair, and eventually picked up a small medium and long wave transistor set. A nice easy job now, thought Dick, would be just the thing to follow his previous praiseworthy performance.

Dick placed the little receiver on his bench and switched it on. Nothing happened. He switched off again, took up a screwdriver and removed the back. The reason for the non-functioning of the receiver was obvious: no battery was fitted. Dick threw a quick glance at the battery connectors and the space available, walked to the spares cupboard and returned with a new PP6 battery, which he inserted and connected up.

He switched on the receiver. The Workshop was at once filled with the deafening sound of the Light Programme reproduced at the total output power of which the little receiver was capable. Hastily, Dick adjusted the volume control, but it had no noticeable effect and the Light Programme roared lustily away at all settings of the control.

"Turn it down a bit," yelled out Smithy over his shoulder.

"What's that you say?"

"Turn it down a bit."

Dick switched off the receiver, and blissful silence returned to the Workshop.

"Thank goodness for that," com-

mented Smithy irritably. "Why do you always have to run these transistor sets at full blast whenever you get one on the bench?"

"This one just wouldn't turn down," explained Dick. "It goes on at full volume regardless of the volume control setting."

"After the speed with which you fixed that TV set just now," pronounced Smithy, "you should be able to diagnose that volume control snag standing on your head."

"How's that?"

"It's obvious," replied Smithy. "Unless something unusual has happened, it's about 99% certain that the bottom end of that volume control track has come unhitched from the rest of the circuit."

Dick pondered for a moment.

"How," he asked, "can you be so sure about it?"

"I'll show you," said Smithy, beckoning his assistant over and pulling his note-pad towards him. "To start off with, practically all these little a.m. transistor sets have the same sort of detector and volume control circuit."

Smithy took out his pen and scribbled a circuit on his pad. (Fig. 1).

"This is the sort of thing you'll find," he continued. "The detector diode is fed from the last i.f. transformer and it feeds into an i.f. filter given by a resistor and two capacitors, and then into the volume control itself. The diode is connected, incidentally, so that the rectified output is positive relative to the positive supply line, and this positive voltage goes back, as an a.g.c. voltage, to the previous transistors. Now, the bottom end of the volume control track is nearly always connected to the positive supply line, and it's almost entirely certain that the uncontrollable volume snag you've got there is due to the bottom end becoming disconnected. (Fig. 2). The result is that,

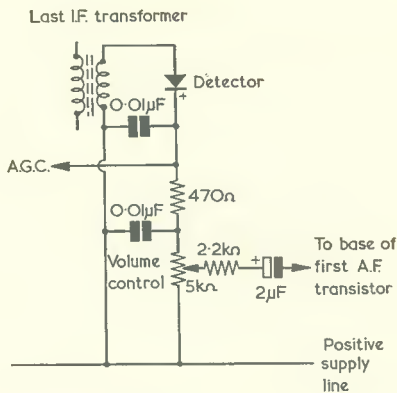

Fig. 1. A typical detector and volume control circuit, with representative component values, as encountered in small transistor a.m. receivers. Occasionally, the i.f. filter resistor (470Ω here) is omitted, the diode coupling directly to the top of the volume control

when you adjust the control, all you're doing is to insert a varying amount of resistance between the detector diode and the base of the first a.f. transistor."

"But," queried Dick, "won't the volume still go down when you turn the control all the way back? You'll then be inserting all the resistance of the volume control in series with the feed to the a.f. transistor."

"The volume will go down a wee bit," conceded Smythy, "but don't forget that the volume control resistance is in series with an i.f. filter resistor and the resistor between the slider and the first a.f. transistor base. In most sets, these two fixed resistors will add up to at least half the resistance of the volume control track, if not more."

"There you are, then," said Dick triumphantly. "If what you say is

true, adjusting the volume control could change the signal at the first a.f. amplifier over a range of as much as 3 to 1."

"Even so," replied Smythy, "a drop to a third in a.f. signal level is not as much, subjectively, as you might think. Don't forget that, in this case, the signal passed to the output stage is so high, anyway, that it's probably being clipped like billy-oh at all levels."

Dick decided to try another angle.

"What about the a.g.c. voltage?" he asked. "Without a diode load this will go up, won't it?"

Smythy sighed.

"I'm just beginning to realise," he remarked wearily, "that I've got myself caught up in an argument about the performance of a circuit which isn't even working properly

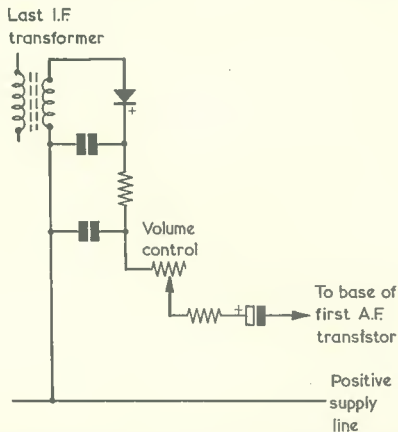

Fig. 2. Smythy diagnosed that the lower end of the volume control in Dick's receiver had become disconnected from the positive supply line. It would then function as a series variable resistor, as shown here

in the first place! Yes, I agree that the a.g.c. voltage may well go up, but I must then point out that the whole receiver will nevertheless stabilise at a sensitivity which will still allow a good hefty rectified signal voltage to appear after the detector diode. Don't forget also that we get a strong Light Programme signal in this locality. And I'll now repeat that that fault is almost certain to be due to an open-circuit at the earthy end of the volume control track."

With which pronouncement, Smythy turned resolutely back to his bench.

"Why," continued Dick inexorably, "couldn't the fault be due to a short-circuit between the slider and the upper end of the track?"

"Because, you great chump," snorted Smythy, turning round once more, "the detected signal would then be short-circuited when the slider was at the bottom end of its track. You'd get some effect of volume control, even if it wasn't the right effect."

Smythy turned back again to his bench and, with grim determination, picked up his soldering iron.

"You said just now," offered Dick chattily, "that the bottom end of the volume control track is nearly always connected to the positive supply line. What happens when it isn't?"

Smythy's soldering iron descended on to its rest with unusual violence.

"Am I ever," he asked, through clenched teeth, "to be allowed to get any work done? If you must know, the usual alternative to the direct connection is to return the bottom of the volume control to a resistor in a negative feedback loop working from the output stage. Like this. (Fig. 3). You'll occasionally bump into this sort of thing with sets which were made before complementary output stages came into fashion, and the resistor between the volume control and the positive supply line will normally be less than 10Ω. And, finally, I would hazard a guess that you might find slightly different volume control circuits in some of the imported sets which use n.p.n. transistors in the i.f. stages. But so far as normal British sets are concerned, the volume control circuit will almost inevitably be one of the two types I've just discussed."

Ohmmeter Tests

With an air of finality, Smythy once more picked up his soldering iron and proceeded to apply it to the chassis in front of him.

It was obvious that the audience was at an end. Dick wandered

back to his own bench and thoughtfully considered the little transistor receiver. Now that its back had been removed, all the components above the printed circuit board were visible, these including the volume control, with its tags, and the 2-gang tuning capacitor. Dick decided to follow Smithy's advice and check the connection between the earthy volume control tag and the positive supply line. He sat down, pulled his testmeter towards him, switched it to an ohms range, and carefully adjusted its zero-set control. He then clipped one of the testmeter leads to the frame of the tuning capacitor.

He located the tag of the volume control at the low volume end of the track and applied the remaining test clip to this.

The testmeter indicated 900Ω.

Dick frowned and removed the test leads. There was obviously no direct connection here. He applied the test leads again, whereupon the meter needle once more returned to 900Ω.

Dick removed the testmeter leads, laid them down on his bench, and assumed the expression of one who cogitates deeply. After several moments of this, he scratched his head furiously. Finally, he re-applied the testmeter leads.

The testmeter indicated 2.5kΩ.

Dick's eyebrows shot up with surprise and he looked closely at the testmeter scale. The needle remained, unwavering, at 2.5kΩ. A little warily, Dick removed the test leads and decided to follow another tack.

He switched on the receiver, which immediately burst forth with the Light Programme at full strength, and hastily tuned it to a quiet part of the dial. Resting his chin in his clenched fists, he looked down at the printed circuit board and scowled prodigiously. A minute passed, after which he once more re-applied the testmeter leads.

The testmeter needle shot violently backwards against its end stop, whereupon Dick hastily removed the test leads and backed away from the set.

It was at that precise moment that Smithy, having finished his own repair, decided to turn round to see how his assistant was getting on.

"What on earth," he exploded, "do you think you're up to now?"

"It's that set," spluttered Dick. "The darned thing's haunted! I first of all checked the circuit from the bottom of the volume control track and I got a resistance of 900Ω. Without doing anything at all, I

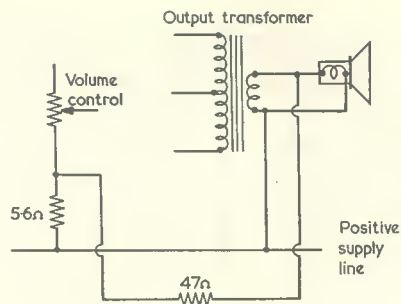

Fig. 3. In some earlier receivers a negative feedback loop from the output stage to the bottom of the volume control may be encountered. A typical instance is shown here, in which the output transformer feeds a 3Ω loudspeaker

checked it again and it had changed to 2.5kΩ. And, snap me, when I check it for the third time I don't get just ordinary resistance—I get *negative* resistance!"

Smithy walked quickly to Dick's bench and glanced at the receiver and Dick's testmeter.

"Am I to believe," he asked in acid tones, "that you've been doing ohmmeter tests with that set switched on?"

Dick blenched.

"Come to think of it," he stammered, "I suppose I did do the last test like that. I was so mystified by the previous readings that I must have got carried away."

"There are times," snorted Smithy, "when I fervently wish that that is just what *would* happen to you.

How the Workshop testmeters stand up to having a ham-handed Henry like you handle them just about baffles me. Between what points were you checking?"

"Between the bottom end of the volume control track and the positive supply line."

"Show me."

Quickly switching off the receiver, Dick applied the testmeter leads yet again to the volume control tag and the tuning capacitor frame. The much-travelled meter needle rose obligingly to indicate 900Ω.

"There you are," said Dick, his confidence returning. "That's exactly the same reading as I got first time. I took the leads off, put them back again, and then I got 2.5kΩ."

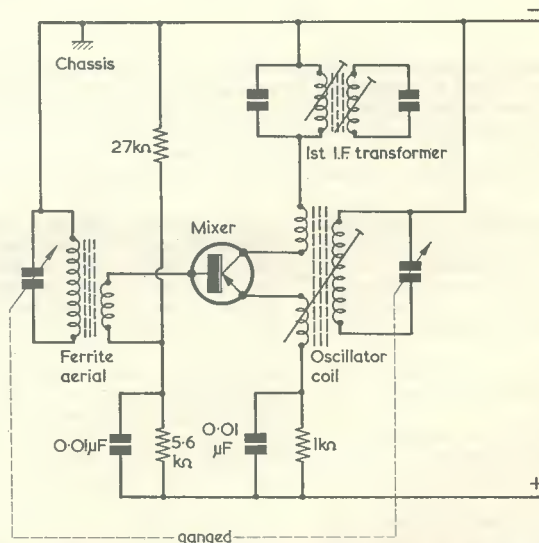

Fig. 4. The mixer circuit of a transistor radio is not complicated by having the tuning capacitor frame connect to the negative instead of the positive supply line. This diagram shows the basic approach. Wave-change switching and trimming and padding capacitors are omitted for simplicity

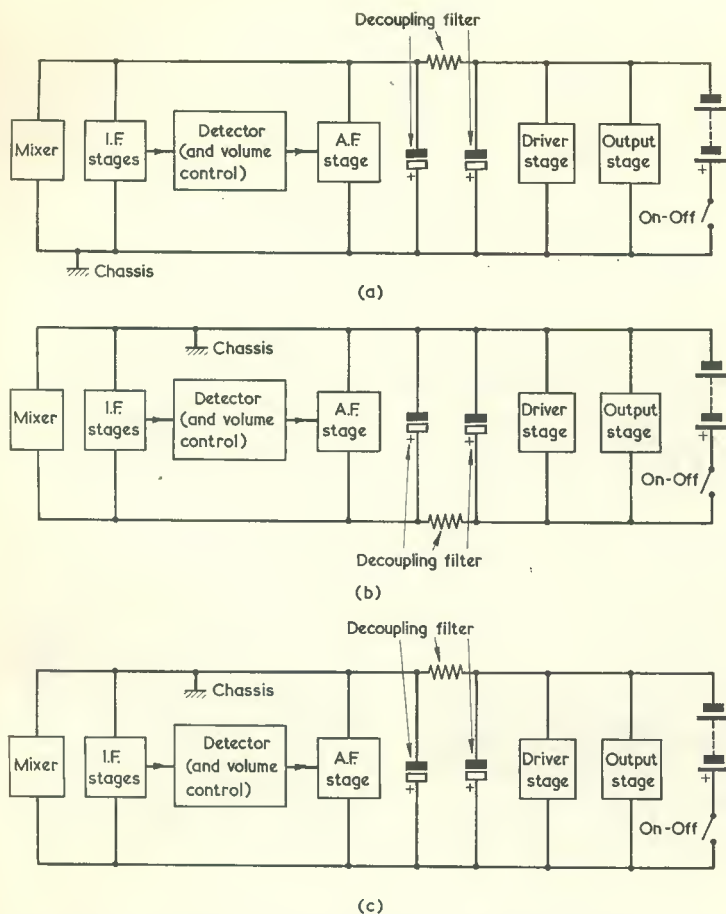

Fig. 5. Three different methods of providing the connection to the chassis (i.e. the major items of metalwork) in transistor receivers. In all cases the decoupling filter resistor will have a value in the order of 180 to 470 Ω , and the electrolytic capacitors will have values of some 100 to 200 μF . (The right-hand capacitor is, of course, that appearing directly across the battery.) The on-off switch could alternatively be in the negative battery lead

"I'm not surprised," commented Smyth. "From what you've been telling me, I would guess that you've been measuring the resistance between the positive and negative supply lines of the receiver!"

"Hey?"

Even Smyth had to chuckle at the dumbfounded expression on Dick's face.

"You've made the assumption," he said, "that the tuning capacitor frame is at the same potential as the positive supply line. What you forget is that many transistor sets are made these days in which the tuning capacitor frame, and indeed much of the metalwork in the receiver, is connected to the negative supply line."

"You're joking!"

"Of course I'm not joking," replied Smyth. "There's no reason why the chassis—that is, the major items of metalwork—in these sets shouldn't just as readily be common to the negative supply line as to the positive line. The two supply lines are coupled together by a large-value bypass capacitor which offers negligible impedance at r.f. and a.f. So, should it suit the designer to make the chassis common to the negative supply line, there's nothing to stop him."

"But," protested Dick, "if the tuning capacitor frame is common to the negative supply line, how is it coupled to the aerial and oscillator coils?"

"In pretty well the same way as when the chassis connection is on

the positive side," said Smyth, reaching over to pick up his notepad from his bench. "Here's an example of the basic mixer circuit you bump into when the tuning capacitor frame is at negative supply line potential. (Fig. 4). As you can see, it's pretty well the same as for the positive chassis. I should warn you, though, that you'll find some variations on this particular theme, the main one being the introduction of coupling capacitors in either the base or the emitter circuits of the mixer."

Dick looked discouraged.

"I don't know," he grumbled. "Nothing seems to remain static these days. Set designers are always changing things."

"And a jolly good thing, too," commented Smyth approvingly. "It helps to separate the men from the boys. Now that I've started, I'd better give you the overall picture on this chassis connection business. Most transistor sets have the positive supply line at chassis potential whereupon you get a set-up like this. (Fig. 5 (a)). As you can see, there is the usual decoupling filter between the output and driver stages, and the rest of the set. Receivers with the negative supply line at chassis potential fall into two categories. In one, the negative line supplies all the stages and the decoupling filter resistor is in the positive supply line. (Fig. 5 (b)). And in the other the decoupling filter resistor is in the negative supply line and the chassis connection is made to this line after the filter. (Fig. 5 (c)). You want to keep your eyes skinned for these two categories, or you'll find yourself getting some mighty peculiar readings if you take testmeter checks from what you fondly imagine is the positive supply line."

Smithy To The Rescue

"I certainly got some peculiar readings just now," said Dick. That resistance reading changed from 900 Ω to 2.5k Ω without my touching anything!"

"I have little doubt that it did," said Smyth shortly. "But before we go any further into that little matter, let's just establish a few minor points. As we haven't got the service sheet out for this set, I'll play the next bit off the cuff."

Smyth removed the battery clips from the battery and connected one of the testmeter leads to the negative clip. He switched on the receiver and applied the other lead to the tuning capacitor frame. The meter indicated zero resistance.

"That's cleared point No. 1," remarked Smithy cheerfully. "We've confirmed that, in this set, the chassis connection is to the negative supply line. Also, since there was no resistance shown by the meter, the decoupling filter resistor will be in the positive line. From what you told me, I think that volume control tag is connected to the positive line, so I'll make that the next point to establish."

Smithy next measured the resistance between the earthy volume control tag and the positive battery clip. The meter indicated 390Ω. (Fig. 6 (a)).

"That," explained Smithy, "will probably be the resistance in the decoupling filter resistor. Let's next find a fat electrolytic on the board whose positive lead-out similarly reads 390Ω to the positive battery clip."

Smithy cast an eagle eye over the printed circuit board. He removed the test clip from the volume control tag and applied it to the positive lead-out of a large-value electrolytic capacitor. The testmeter once more indicated 390Ω. (Fig. 6 (b)).

"Good," grunted the Serviceman, "I've struck gold first time!"

Smithy finally applied his testmeter leads between the positive lead-out of the electrolytic capacitor and the volume control tag. The testmeter now indicated zero ohms. (Fig. 6 (c)).

"Well, that's good enough for the moment," remarked Smithy, "I'm going to assume that that volume control tag is definitely connected to the positive line after the decoupling filter, as it should be. Incidentally, the little exercise I've just carried out is a good example of how you can find your bearings in a transistor set if you haven't got the service sheet, and you're working on the component side of the board only."

"Fair enough," commented Dick. "But I'm still puzzled as to why I got those different resistance readings."

"You must have transposed the testmeter leads between the readings," replied Smithy. "Don't forget that, when it is switched to an ohms range, a testmeter applies a voltage to the resistance it is measuring. It has to, because what the meter actually reads is the current which flows through the resistance being measured. If you apply the test leads across the supply lines of a transistor radio you're almost certain to get different readings when you change them over. With the leads connected one way, all or most of the transistors will be passing current and with the leads connected the

other way round they'll all be non-conducting, whereupon you'll just get the resistance given by the base supply potential dividers and by leakage in the electrolytics."

To prove the point, Smithy connected Dick's testmeter to the volume control tag and the tuning capacitor frame. The meter read 900Ω. Smithy reversed the test leads, whereupon the meter read 2.5kΩ. (Fig. 7)

"Which also explains that little point," commented Smithy. "What is not explained is why someone who has just carried out, to use his own words, a masterly diagnosis on a TV set, should then be so dim as to apply the ohmmeter leads to the set with the battery switched on. Negative resistance indeed!"

"But the needle *did* go backwards!"

"I'm not surprised," replied Smithy. "You were applying something like 7 to 8 volts across the meter leads, which is a lot higher than the voltage of the little testmeter battery which is switched in on ohms ranges. The current which flowed could easily cause a reverse

current to appear in the meter movement."

Smithy stopped abruptly and surveyed his assistant distrustfully.

"Blimey, Smithy," said that young man uneasily. "Why are you looking at me like that?"

"It's because of a thought," said Smithy suspiciously, "which has just passed through my mind."

"A thought has just passed through mine, too," said Dick quickly, eager to steer the conversation away from what seemed to be a potentially perilous area. "You said at the beginning that it was 99% certain that the bottom end of the volume control track was disconnected from the positive supply line. What I don't understand is that you've now found that the bottom end of the track very probably is connected, and yet you don't seem to be at all put out about it."

"I'm not," replied Smithy, "as I now hope to demonstrate to you."

Smithy reconnected the battery leads and the receiver, already switched on, came to instant life. Smithy returned the dial to the Light

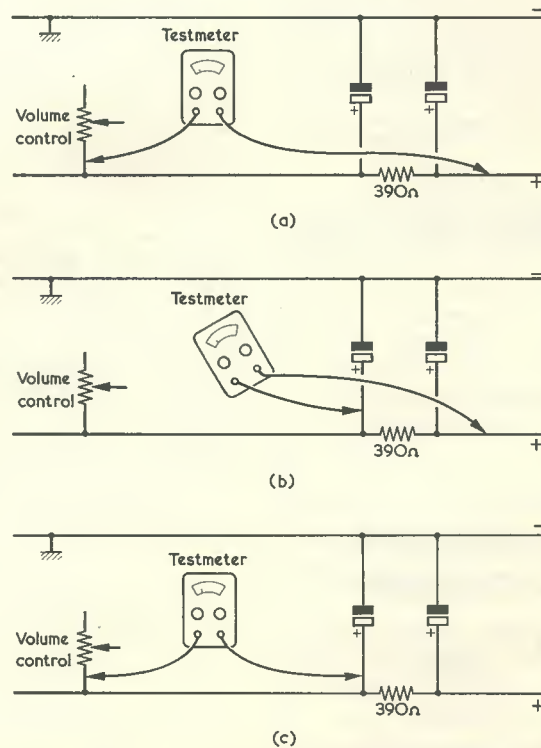

Fig. 6. Three simple steps in finding one's way about an unfamiliar receiver without the service sheet and working from the component side of the board only. The 390Ω resistor and the two electrolytic capacitors form the decoupling filter of Fig. 5 (b). The testmeter is switched to an ohms range

Your Local Supplier
LONDON AREA

Established 1910

**H. L. SMITH
& CO. LTD.**

Comprehensive stocks of components
by all leading makers.

287-9 EDGWARE ROAD
LONDON W.2

Tel: 01-723 5891

**CRESCENT
RADIO LTD**

North London's electronic centre.
Quality components at competitive
prices.

Transistors, Diodes, Valves,
Speakers, Resistors, Condensers,
Cables, Plugs and Sockets, etc., etc.

40 MAYES ROAD,
WOOD GREEN,
LONDON, N.22

**THE
MODERN BOOK CO.**

Largest selection of English and
American radio and technical books
in the country.

19-21 PRAED STREET,
LONDON, W.2

Tel: PADdington 4185/2926

**TELERADIO
ELECTRONICS**

For Radio Control Devices, Miniature
components, Special Transistors,
Circuits and data on boat and
aircraft control.

(S.A.E. Enquiries REF. D/P)

325/7 FORE STREET,
EDMONTON (3719)
LONDON, N.9.

IN YOUR WORKSHOP

(continued)

Programme and picked up a small screwdriver.

"I'll first," he yelled, over the racket from the tiny loudspeaker of the set, "short out the slider and earthy tags of that volume control."

Smithy applied his screwdriver to the tags in question. At once the receiver became silent.

"That finally proves," said Smithy cheerfully, "that that earthy tag is connecting properly. I'm now going to have a little dig around!"

Smithy removed the screwdriver blade from the volume control tags, whereupon the raucous clamour from the loudspeaker filled the Workshop again. Carefully, Smithy next applied the screwdriver blade to the rivet which secured the earthy tag to the volume control moulding. Suddenly, the sound from the receiver dropped to a comfortable level, and he removed the screwdriver. He adjusted the volume control. It functioned perfectly.

Dick was patently greatly impressed at this exercise of legerdemain.

"Corluvaduck," he remarked admiringly. "Smithy, you're a genius!"

"Just a matter of luck," replied Smithy modestly. "The real snag here was that the open-circuit was in the potentiometer itself. (Fig. 8). The connection from tag to track is made by way of the rivet which secures the tag to the moulding, and in this case the rivet couldn't have been thumped down hard enough when it went through the pot factory. All I did just now was to give the rivet a slight dig with the screwdriver blade, and the resultant tiny shift in its position must have made the connection good again."

"Well, I'm blowed," remarked Dick enthusiastically. "At any rate, that means that this little set is now repaired and is all ready to go out."

"I'm afraid not," pronounced Smithy. "You'll have to pop a new volume control in it. You see, I've

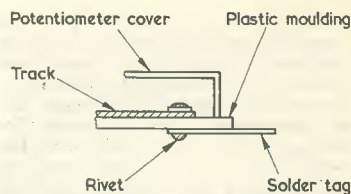

Fig. 8. Showing how a single rivet may be used to provide the connection between a solder tag and the track of a potentiometer

only made the rivet connection good temporarily, and it's pretty sure to go open-circuit again at some future date. So it's necessary to fit a new pot there, my lad!"

True Confessions

"Righty-ho," said Dick eagerly, "I'll get it changed right away." "Good show," replied Smithy absently.

It was obvious that the Serviceman's mind had reverted to his previous passing thought.

"What I still can't understand," he continued, "is how, after doing a fairly complicated TV snag in no time at all, you should make a complete cobblers' of a simple little job like this one."

"I suppose," confessed Dick reluctantly, "I'll have to tell you the whole story about that TV. The open-circuit screen-grid resistor I mentioned stuck out a mile. It was just about burned down to a cinder."

"And," broke in Smithy, "I suppose the screen-grid bypass capacitor was good and short-circuit as well?"

"It was," agreed Dick ruefully. "I'll have to admit that the snag was so glaringly obvious that it couldn't possibly have been missed."

To Dick's amazement, Smithy's reaction to this news was merely a non-committal grunt, after which the Serviceman retired to his bench. As Dick replaced the faulty volume control he pondered on the mysteries of life including, in particular, the

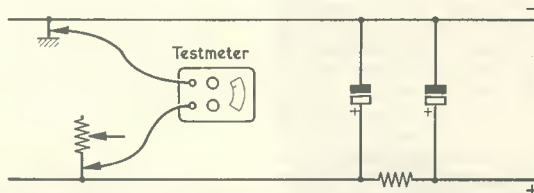

Fig. 7. When Dick checked between the earthy volume control tag and chassis (actually, the tuning capacitor frame), he was measuring the resistance between the negative and positive supply rails! Due to the transistors in the receiver, a different resistance is given if the testmeter leads are reversed

more enigmatic facets of Smithy's character.

Smithy was also in a ruminative mood as he bent over the next receiver he had chosen for repair. For a brief moment, the quick and successful repair of that TV set had raised the chilling thought that his assistant was becoming highly proficient. It had been quite a relief to

learn, during the episode of the transistor receiver, that Dick still continued at his normal floundering level.

After all, mused Smithy darkly, if the Staff became as knowledgeable as the Guv'nor, there might eventually be no need for a Guv'nor at all . . .



CAN ANYONE HELP ?

Requests for information are inserted in this feature free of charge, subject to space being available. Users of this service undertake to acknowledge all letters, etc., received and to reimburse all reasonable expenses incurred by correspondents. Circuits, manuals, service sheets, etc., lent by readers must be returned in good condition within a reasonable period of time

Early Detection Methods.—M. J. Lynch, Dungan, Landscape Park, Churchtown, Dublin 14—appreciate any information that would assist in research on these methods.

* * *

Elizabethan FT3 Tape Recorder.—R. Hammond, 126 Otley Drive, Gants Hill, Ilford, Essex—requires a circuit diagram and information on fitting a record level meter.

* * *

VHF Receiver R1949.—M. J. Vaughan, 16 Fortfield Grove, Terenure, Dublin, 6—manual or circuit of this Air Ministry surplus receiver.

* * *

Regentone Radiogram.—P.O.R.E.L. J. German, P.O.'s. Mess, H.M.S. Tartar, B.F.P.O. Ships—circuit urgently required, no pattern or design number visible, made sometime around 1949–1952, LW, MW, VHF, Gram (3-speed).

* * *

Indicator Unit CRT Type 1.—J. W. Clubb, 38 Clunie Road, Dunfermline, Fife—any information, circuit or manual of this unit (Ref: No: 10Q/53).

* * *

WS46 Receiver.—A. Giles, 20 Fieldway, Dagenham, Essex—circuit diagram or any details of this receiver.



NEW PLESSEY MINIATURE RESISTORS

A new range of miniature low ohmic wire-wound resistors, especially developed to meet the requirements of modern transistor equipment, has been introduced by the Resistor Division of the Plessey Components Group.

The resistors, designated Type TW and Type TP, fulfil the need in such equipment for space-saving as well as for low ohmic values. They are scaled down versions of the Group's proven glass fibre cored resistor, and are available with both wire and printed circuit terminations with a 0.3in. and 0.4in. spacing between pins.

Finished in green silicone cement, Type TW and TP resistors have an overall resistance range from 0.22Ω to 6.8kΩ at 1 watt rating. They can be wound with copper wire where the temperature coefficient characteristics of copper are required.

Your Local Supplier

ESSEX

ELECTRONIC COMPONENTS

Valves, transistors, capacitors, transformers, amplifiers, tuners, etc., etc.

765 HIGH ROAD,
SEVEN KINGS
(opp. Seven Kings Hotel)
ILFORD, ESSEX

Telephone: GOOdmayes 1826

MARKET CENTRE

For Semiconductors

Prompt, efficient mail order service for Mullard, Newmarket, Texas, Sinclair, S.T.C., Fairchild Semiconductors. We also offer a comprehensive selection of miniature components for transistor circuitry. Catalogue 1s.

L.S.T COMPONENTS
23 New Rd., Brentwood, Essex

LANCASHIRE

BERWICK ELECTRONICS LTD.

Stockists of radio components for the constructor. Cabinet coverings—Tygan, Vynair, Metal Fret etc.

100 Tib Street, Manchester 4
Telephone Blackfriars 4416

NEW CROSS RADIO

Electronic components and Equipment,
Transistor Panels,
all at competitive prices

6 Oldam Road, Newcross
Manchester 4
Telephone CEN 1541

TV

FAULT FINDING MANUAL for 405/625 LINES

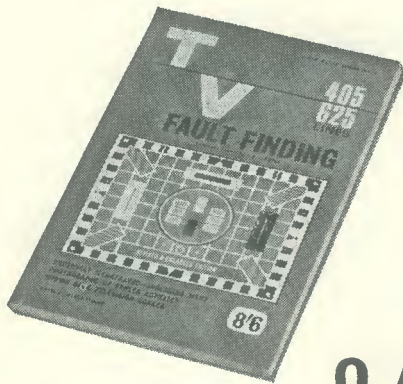

8/6

POSTAGE 8d.

REVISED & ENLARGED

EDITED BY J. R. DAVIES

124 pages

Over 100 illustrations, including 60 photographs of a television screen after the appropriate faults have been deliberately introduced.

Comprehensive Fault Finding Guide cross-referenced to methods of fault rectification described at greater length in the text.

UNDERSTANDING TELEVISION

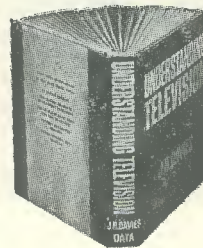

by

J. R. DAVIES

Over 500 pages

300 diagrams

37/6 POSTAGE
2/6

UNDERSTANDING TELEVISION deals with:

- Principles of 405 line reception
- Principles of 625 line reception
- Nature of the television signal
- Receiver tuner units
- A.F. and video amplifiers
- Deflector coil assemblies
- Automatic gain and contrast control
- Receiver aerials
- The cathode ray tube
- Receiver i.f. amplifiers
- Vertical and horizontal timebases
- Synchronising
- Power supply circuits
- Colour television
- **COLOUR TELEVISION** — 80 page section deals comprehensively with this subject

The reader is required to have only a basic knowledge of elementary radio principles. The treatment is non-mathematical throughout, and there is no necessity for any previous experience in television whatsoever. At the same time, UNDERSTANDING TELEVISION is of equal value to the established engineer because of the very extensive range it covers and the factual information it provides.

To Data Publications Ltd., 57 Maida Vale, London, W9

Please supply the 4th revised edition of TV FAULT FINDING, Data Book No. 5

Please supply UNDERSTANDING TELEVISION, Data Book No. 17

I enclose cheque/crossed postal order for.....(Tick which book is required)

NAME

ADDRESS

BLOCK LETTERS PLEASE

BI-PAK SEMICONDUCTORS

8 RADNOR HOUSE
93/97 REGENT STREET
LONDON, W.1

★ VALUE PAKS for '67
NEW, UNTESTED

LOW COST SILICON CONTROLLED RECTIFIERS (THYRISTORS) FACTORY TESTED
 1 AMP (TO-5 can) PIV EACH 8/6
 50 9/6
 100 22/6
 200 22/6
 400 22/6

7 AMP (STUD) PIV EACH 10/6
 100 30/-
 400 45/-

16 AMP (STUD) PIV EACH 16/6
 100 35/-
 400 55/-

Free SCR Literature including
Circuit Diagrams for Light
Dimmers, Speed Controllers
AC Power Switch, etc., with
SCR orders or on request.

120 Germ. Diodes 10/-
Sub-min.

20 All types Zeners 10/-
Mixed Volts.

25 Transistors 10/-
Silicon N.P.N. 200 m/cs.

20 Rectifiers 10/-
1 amp. Germ. up to 300 PIV

60 Silicon Diodes 10/-
200 mA

16 Rectifiers 10/-
Silicon 750mA Top-Hat

40 Transistors 10/-
LIKE OC81 & AC128

10 Silicon Rect. 10/-
2 AMP. STUD

FREE One 10/- Pack of your own choice free with orders valued £4 or over

FREE 6. 2N2926 SPECIAL OFFER 20/-

VALUE PAK 50 TRANSISTORS MIXED UNTESTED **10/-**

UNMARKED, UNTESTED VOLTAGE RANGE 1 Amp 50-400 PIV **20/-**

3 OC139 Trans. NPN Mullard	10/-
2 Drift Trans. 2N 1225 100 M/Cs PNP	10/-
6 Matched Trans. OC44/45/81/81D	10/-
4 OA10 Diodes Mullard	10/-
15 Red Spot AF Trans. PNP	10/-
15 White Spot RF Trans. PNP	10/-
4 Sil. Rects. 3A 100/400 PIV	10/-
4 NPN Trans. OC139 2N1302, ETC.	10/-
2 10 Amp. Sil. Rect. 50/100 PIV	10/-
8 Diodes 4 OA70, 4 OA79	10/-
1 5 Amp. SCR 100 PIV	10/-
5 GET884 Trans. Eqvt. OC44	10/-
10 Assorted Computer Diodes	10/-
4 Zeners 5, 6.8, 10, 12 Vits	10/-
2 2G417 Trans. Eqvt. AF116/117	10/-
2 200 M/Cs S. I. Trans. BSY26/27	10/-
2 Bi-directional Trans. ASY65	10/-
4 High Current Trans. OC42	10/-
2 Power Trans. OC26/35	10/-
5 Sil. Rects. 400 PIV 250mA	10/-
3 OC71 Trans. Mullard	10/-
3 NPN Sil. Trans. 70 M/Cs	10/-
3 OC76 Trans. Mullard	10/-
5 OA47 Gold Bonded Diodes	10/-
4 OA202 Sil. Diodes Sub.-min.	10/-
3 OC77 Trans. Mullard	10/-
8 OA81 Diodes CV448	10/-
3 Sil. Rects. 400 PIV 500 mA	10/-

3 High vit. AF Trans. PNP ACY17	15/-
3 BC108 Sil. Trans.	15/-
3 BSY95A Sil. Trans. STC	15/-
3 Sil. Trans. OC200 Mullard	15/-
2 Sil. Power Rect. 6 Amp. 200 PIV BYZ13	15/-
1 AF139 GERM. Trans. 1500 M/Cs	15/-
1 Sil. Power Trans. 100 M/Cs TK201A NPN	15/-
6 Zener Diodes 3-15 vits. Mixed 400mW	15/-
5 OA5 Gold Bonded Diodes Mullard	15/-
1 2N1132 PNP PLANAR Trans. Sil.	15/-
2 2N697 NPN PLANAR Trans. Sil.	15/-
1 AF139 GERM. Trans. eqvt. OC16 Mullard	15/-
1 UNIJUNCTION Trans. 2N2646 G.E.	15/-
2 Sil. Trans. 60VCB 200 M/Cs ZT83/84	15/-
1 Sil. PLANAR Trans. BSY25 NPN 100 M/Cs	15/-
1 Sil. Trans. IS104 150 M/Cs HFE 200 NPN	15/-
2 SCR's 50 PIV 1 Amp. TO-5 can.	15/-
1 Tunnel Diode IN3720 (TD-5) G.E.	15/-
1 2N2160 UNIJUNCTION Trans. TO-5 can	15/-
2 Sil. Rect. 5 Amp. 400 PIV Stud.	15/-
1 Tunnel Diode AEY11 STC. 1050 M/Cs	15/-
2 GERM. Power Trans. OC28/29	15/-
2 Zeners 25 Watt 18 & 22 Vits.	15/-
6 Sil. Rect. Type BY 100 800 PIV 550mA	20/-
8 Sil. Rect. 400 PIV 200/500mA	20/-
1 Transistor Manual by G.E. 648 pages.	30/-
1 Silicon Controlled Rect. Manual G.E.	30/-
25 Mixed Sil. & GERM. Trans. New Marked	30/-
40 Mixed Semiconductors New Marked	40/-
1 Logic Module Handbook & Catalogue	17/6

Our vast stocks change daily with hundreds of Semiconductor bargains becoming available. Just send 2/6 to cover 3 months mailing of our latest stock lists, eqvt. charts, circuits, etc.

Minimum Order 10/-. CASH WITH ORDER PLEASE. Add 1/- postage and packing per Order. GUARANTEED by return postal service. Overseas add extra for Airmail.

A complete range of Sil. Rect. 750mA to 25 amp 50-1000 PIV now in stock. Ask for Price List.

THE MODERN BOOK CO

Hi Fi Year Book, 1966/7. 15s. Postage 1s 6d.

ABC'S of Antennas. By A. Lytel. 16s. Postage 1s.

Transistor Bias Tables (Germanium). By E. Wolfendale. 21s. Postage 1s.

Servicing Transistor TV. By R. G. Middleton. 30s. Postage 1s.

1967 World Radio TV Handbook. 32s. Postage 1s.

Transistor Ignition System Handbook. By B. Ward. 22s. 6d. Postage 1s.

Outline of Radio and Television. By J. P. Hawker. 30s. Postage 2s.

Radio Circuits. By W. E. Miller. Revd by E. A. W. Spreadbury. 25s. Postage 1s.

Transistor Transmitters for the Amateur. By D. L. Stoner. 21s. Postage 1s.

Radio Valve Data. Compiled by "WW" 8th ed. 9s. 6d. Postage 1s.

Transistor Specifications and Substitution Handbook. 1967. Ed. by Tech. P. 21s. Postage 1s.

Questions and Answers Electronics. By C. Brown. 8s. 6d. Postage 6d.

Elementary Telecommunication Practice. By J. R. G. Smith. 13s. 6d. Postage 9d.

Questions and Answers Transistors. By C. Brown. 8s. 6d. Postage 6d.

Mathematics for Telecommunications and Electrical Engineering. Vol. 1. By D. E. Spooner and W. H. Grinstead. 15s. Postage 9d.

Transistor Pocket Book. By R. G. Hibberd. 25s. Postage 1s.

Basic Piezoelectricity. By J. Potter Shields. 20s. Postage 1s.

Basic Electronics. By U.S. Navy. 22s. Postage 1s. 3d.

We have the Finest Selection of English and American Radio Books in the Country

19-21 PRAED STREET (Dept RC) LONDON W2

Telephone PADDington 4185



Happy Families

These are the times when Simon and Clare know that it has all been worthwhile. But they know too that such moments of happiness are only complete when there is also a feeling of security for the future. And Simon's "Family Unit" Policy with the "Yorkshire" guarantees them *all* a future - if the worst should happen.

Happiness in *your* family too—but for how long? If you or *your wife* should die, how would the rest of the family fare? A Yorkshire "Family Unit" policy provides for both these eventualities in a comprehensive way at a sensible premium. Just ask for a leaflet at your local "Yorkshire" branch and then see the manager. He'll be glad to tell you why ...

it's **YORKSHIRE** for **INSURANCE**

THE YORKSHIRE INSURANCE COMPANY LIMITED

Chief Offices: Rougier Street, YORK
and Becket House, 36-37 Old Jewry, LONDON, E.C.2.

Branches and Agencies throughout the world

Please send me details of the Family Unit Policy, without obligation.

Name.....

Address.....

J.B.

SMALL ADVERTISEMENTS

Rate: 9d. per word. Minimum charge 12/-.
Box No. 2/- extra.

Advertisements must be prepaid copy and all must be received by the 4th of the month for insertion in the following month's issue. The Publishers cannot be held liable in any way for printing errors or omissions, nor can they accept responsibility for the *bona fides* of advertisers. (Replies to Box numbers should be addressed to: Box No.—, The Radio Constructor, 57 Maida Vale, London, W.9.)

SERVICE SHEETS, 1925-1967. From 1s. Catalogue 6,000 models, 2s. 6d. S.A.E. enquiries.—Hamilton Radio, 13 Western Road, St. Leonards, Sussex.

100 PAGE ILLUSTRATED CATALOGUE NO. 17 of Government and manufacturers' electronic and mechanical surplus, also a complete new section of the latest semi-conductors and miniature components, includes a credit voucher for 2/6d. Send for your copy now. Price 3/- post free. Arthur Sallis (Radio Control) Ltd., 93 North Road, Brighton, Sussex.

FOR SALE. Oscilloscopes—Galvanometers—Evershed & Vignolles Meggers—Relays—Uniselector Switches—Solenoids. Also other items and components. Free list. Stamp please.—R. & E. Mart, Box 9 G.P.O., Tunbridge Wells, Kent.

TELEPRINTERS 7B complete from £10. Also Auto-transmitters, Reperforators, Signalling Rectifiers, etc., from William Batey & Co. (Exports) Ltd., Gaiety Works, Akeman Street, Tring, Herts. Please ring Tring 3476.

BOOKS FOR SALE. Six Science Fiction Book Club issues, 10s. the lot. Nine *Sunday Times* World Library issues, £1 the lot. Four *Life* World Library issues, 10s. *Yacht Racing* by G. Sambrooke Sturgess, 5th Ed., £1. *Practical Yacht Racing* by Eyrin Schiottz, 10s. *Teach Yourself Russian*, 5s. *Maintenance and Management of Small Locomotives* by H. E. White, 7s. 6d. *Miniature Locomotive Construction* by John H. Ahern, 7s. 6d. *Reeds Nautical Almanac 1965 and 1966 Editions*, 10s. *Atomic Energy and its Applications*, 7s. 6d. *Artificial Satellites* (Penguin) 2s. 6d. All plus postage. Box No. F283.

150 NEW ASSORTED RESISTORS AND CAPACITORS. Silvered mica/ceramic etc. Carbon, hystab, vitreous, ¼ to 20 watt. 12s. 6d. post free. Whitsam Electrical Products, 18 Woodrow Close, Perivale, Middlesex.

TECHNICAL DRAWINGS, Artwork, etc. Electronic and Radio Circuits a speciality. Moderate charges.—B. P. Meaney, 43 Forest Road, Worthing, Sussex.

ARE YOU A MOTORING ENTHUSIAST? The Seven Fifty Motor Club caters for all types of motor sport—racing, rallies, hill climbs, etc. Monthly Bulletin free to members. For full details write to: The General Secretary, Colin Peck, "Dancer's End", St. Winifred's Road, Biggin Hill, Kent.

POSTAL ADVERTISING? This is the Holborn Service. Mailing lists, addressing, enclosing, wrapping, facsimile letters, automatic typing, copy service, campaign planning, design and artwork, printing and stationery. Please ask for price list.—The Holborn Direct Mail Company, 2 Mount Pleasant, London, W.C.1. Telephone: TERminus 0588.

continued on page 574

BENTLEY ACOUSTIC CORPORATION LTD.

38 Chalcot Road, Chalk Farm,
LONDON, N.W.1.
PRImrose 9090

47 Norfolk Road,
LITTLEHAMPTON, Sussex.
Littlehampton 2043

Please forward all mail orders to Littlehampton

IR5	4/-	9D7	7/6	AZ31	8/-	ECL82	6/3	EZ41	6/6	PY88	7/3
IS5	3/3	10C1	12/6	DAF96	6/6	ECL83	10/-	EZ80	3/9	PY800	6/-
IT4	2/6	10C2	12/-	DF96	6/6	ECL85	11/-	EZ81	4/3	PY801	6/3
3Q4	5/3	10F1	9/9	DK40	10/6	ECL86	8/-	GZ34	10/-	UZ25	11/-
3S4	4/3	10F18	7/9	DK92	7/6	EF36	3/6	GZ37	14/6	UZ26	8/6
3V4	5/-	10LD1	9/6	DK96	7/6	EF37A	7/-	HABC80	9/3	U191	10/6
5Y3GT	4/9	10P13	12/-	DL96	6/9	EF39	5/-	PABC80	7/6	U301	12/6
5Z4	7/6	10P14	13/-	DM70	6/-	EF41	9/-	PC86	8/6	U329	9/-
6A05	4/9	12AT6	4/6	DY87	6/3	EF80	4/6	PC88	8/6	U404	6/-
6AT6	4/-	12AU6	5/9	E88CC	12/-	EF85	4/6	PC95	6/9	U801	18/-
6AU6	5/9	12AV6	5/9	EABC80	5/9	EF86	6/3	PC97	6/3	UABC80	5/3
6AV6	5/6	12BA6	5/3	EAF42	7/6	EF89	4/9	PC900	9/-	UF42	7/9
6BA6	4/6	12BE6	4/9	EB91	2/3	EF91	3/3	PC84	5/6	UBC41	6/6
6BE6	4/6	12BH7	6/-	EB41	7/3	EF92	2/6	PC85	6/9	UBC81	6/6
6BH6	5/3	19AQ5	7/3	EBC81	6/3	EF97	10/-	PC88	10/6	UBF80	5/6
6BI6	5/6	20D1	10/-	EBF80	5/9	EF98	9/9	PC89	10/6	UBF89	5/9
6BQ7A	7/6	20F2	11/6	EBF83	7/3	EF183	6/3	PC8189	8/9	UBL21	10/9
6BR7	8/3	20L1	14/-	EBF89	5/9	EF184	5/9	PCF80	6/6	UC92	6/-
6BW6	7/6	20P3	16/-	EBL21	10/3	EH90	9/6	PCF82	6/-	UC84	8/-
6CD6G	22/-	20P4	16/-	EC86	11/6	EL33	12/-	PCF84	8/6	UCC85	6/3
6CH6	6/-	20P5	16/-	EC88	10/6	EL41	8/-	PCF86	6/-	UCF80	8/3
6FI	9/6	30C15	10/6	EC92	6/6	EL42	7/6	PCF801	9/-	UCH21	9/-
6F23	9/-	30C17	11/6	ECC40	10/-	EL84	4/6	PCF802	9/6	UCH42	8/6
6F24	10/-	30C18	7/6	ECC81	3/6	EL85	7/6	PCL82	6/6	UCH81	6/-
6F25	10/-	30F5	10/-	ECC82	4/6	EL86	7/3	PCL83	8/6	UCL82	7/3
6F28	9/6	30FL1	10/-	ECC83	4/6	EL95	5/-	PCL84	7/6	UCL83	9/-
6J5G	3/9	30FL12	13/-	ECC84	5/6	ELL80	14/-	PCL85	8/6	UF41	7/9
6J7G	4/6	30FL14	10/9	ECC85	5/3	EM71	14/-	PCL86	8/-	UF42	4/9
6K7G	1/3	30L15	12/6	ECC88	8/9	EM80	5/9	PFL200	14/6	UF80	6/9
6K8G	3/3	30L17	11/6	ECC189	9/-	EM81	6/9	PL36	9/-	UF85	7/3
6L18	7/6	30P2	9/-	ECF80	7/-	EM84	5/9	PL81	7/9	UF86	9/-
6LD20	6/6	30P19	10/-	ECF82	6/6	EM85	11/-	PL82	5/3	UF89	5/6
6Q7G	5/-	30PL1	13/6	ECF86	8/6	EM87	6/6	PL83	6/-	UL41	8/9
6SL7	4/9	30PL13	13/6	ECH21	10/-	EY51	5/6	PL84	6/3	UL84	6/-
6SN7	4/6	30PL14	13/6	ECH35	6/-	EY81	7/3	PL500	13/6	UM80	8/3
6VG6	3/6	30PL15	13/6	ECH42	8/6	EY83	9/3	PY33	8/9	UY21	9/-
6X4	3/9	35W4	4/6	ECH81	5/6	EY84	9/6	PY80	5/-	UY41	5/9
6X5	5/3	85A2	6/6	ECH83	7/6	EY86	5/9	PY81	5/-	UY85	4/9
630L2	8/9	807	11/9	ECH84	9/-	EY88	8/9	PY82	5/-	VP48	12/-
7Y4	8/-	5763	7/6	ECL80	6/-	EZ40	6/-	PY83	5/6	X41	10/-

Terms of business: Cash with order only. No C.O.D. Post/packing 6d. per item. Orders over £5 post free. All orders despatched same day as received. Complete catalogue including transistor section and components with terms of business 6d. Any parcel insured against damage in transit for 6d. extra. We are open for personal shoppers 9 a.m.-5 p.m. Saturdays 9 a.m.-1 p.m.

20 Suggested Circuits

by G. A. FRENCH

48 pages DATA BOOK SERIES No. 15
Price 3/6d. Postage 5d.

This book contains the first 20 circuits to be published in the very popular series of the same name appearing in *The Radio Constructor*.

The Contents include: simple and inexpensive two-valve capacity bridge, short wave regeneration pre-selector, one-valve speech operated switching circuit, transformer ratio analyser, series noise limiter, receiver remote mains on-off control, and many others; covering subjects ranging from electronic laboratory equipment to a simple 2-Stage Gram Amplifier.

TO DATA PUBLICATIONS LTD 57 Maida Vale W9

Please supply copy(ies) of "20 Suggested Circuits", Data Book No. 15. I enclose cheque/crossed postal order for.....

NAME

ADDRESS

NEW STYLE SELF-BINDER for "The Radio Constructor"

The "CORDEX" Patent Self-Binding Case will keep your issues in mint condition. Copies can be inserted or removed with the greatest of ease. Rich maroon finish, gold lettering on spine.

Specially constructed Binding Cords are made from Super Linen of great strength, very hard twisted and twice doubled. They

are attached to strong RUSTLESS Springs under tension, and the method adopted ensures PERMANENT RESILIENCE of the Cords. Any slack that may develop is immediately compensated for, and the Cords will always remain taut and strong. It is impossible to overstretch the springs, as a safety check-device is fitted to each.

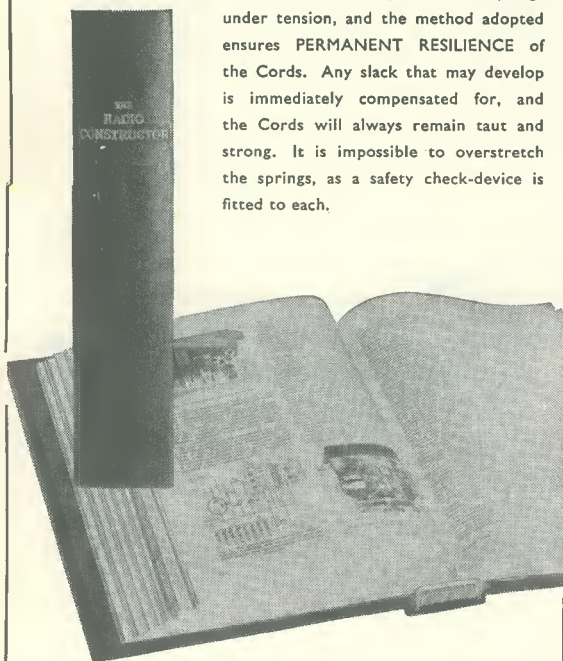

For your other magazines see opposite

PRICE **15/-** Post Free

Available only from:—

Data Publications Ltd.
57 Maida Vale London W9

SMALL ADVERTISEMENTS

continued from page 573

"MEDIUM WAVE NEWS" Monthly during DX season—Details from: B. J. C. Brown, 60 White Street, Derby.

JOIN THE INTERNATIONAL S.W. LEAGUE. Free Services to members including Q.S.L. Bureau. Amateur and Broadcast Translation. Technical and Identification Dept.—both Broadcast and Fixed Stations, DX Certificates, contests and activities for the SWL and transmitting members. Monthly magazine, *Monitor*, containing articles of general interest to Broadcast and Amateur SWLs, Transmitter Section and League affairs, etc. League supplies such as badges, headed notepaper and envelopes. QSL cards, etc., are available at reasonable cost. Send for League particulars. Membership including monthly magazine, etc., 35s. per annum.—Secretary, ISWL, 60 White Street, Derby.

MESSERSCHMITT Four wheel TG 500 sports car. Enthusiast seeks damaged or part vehicles, spares etc. Details to C. E. Jaques, 33 Middleton Road, Shenfield, Essex.

PROPERTIES for sale and to let in London and suburbs. Apply to Maggs & Stephens, Estate Agents, 229 Maida Vale, London, W.9. MAIDA VALE 8123.

FOR SALE. Heathkit RA1. Unused. With xtal calibrator and speaker £40. Lovell, 5 Montpelier Road, Ilfracombe, Devon.

TORIOD COILS for sale. Suitable RTTY, etc. Mostly 88mH but some values above and below. SAE for details. 7s. 6d. each. Box No. F289.

FOR SALE. STROBOSCOPES No. 2, (643 rpm) and No. 4 (666.6 rpm), at 7s. 6d. 0-12 oz., tension gauge at 7s. 6d. Box No. F290.

WANTED. Glass paper-weights. Swap for radio gear or pay cash. Offers to:— Box No. F291.

FOR SALE. Rectifier Units, Type 43A. 50s. plus carriage. Box No. F292.

FOR SALE. Cossor 339 double beam scope £30. Thurlow, 210 Copnor Road, Portsmouth, Hants. (Tel: 64728).

BRIGHTEN UP YOUR ADVERTISING! Break the ice with a cartoon, "tailor made" for your product. Reasonable charges. Box No. F294.

WANTED. Model yacht about 4ft long, for conversion to radio control. Box No. F295.

TAPE RECORDER SPARES. All parts for any machine available. Send S.A.E. and requirements for quote to: Tape Service, 81 Lower Richmond Road, London, S.W.15.

WIRELESS MICROPHONE. (Sub-Min). Could possibly be built in cigar tube. Circuit & details for 5s. Box No. F296.

OFFERS INVITED for "The Radio Constructor" Volumes 8 to 19. First seven volumes bound. Guthrie, 3 Deansgate Terrace, Grimsby, Lincs.

ESSEX GARDENERS. Buy your bedding and rock plants, shrubs, etc., also cacti, from May's Nurseries, 608 Rayleigh Road, Hutton, Brentwood, Essex. Callers only, Monday to Saturday.

continued on page 575

SMALL ADVERTISEMENTS

continued from page 574

THE RADIO CONSTRUCTOR. D. Dulborough-
"Quantock", Adie Road North, Greatstone, Kent,
wishes to buy or borrow copies of August and Septem-
ber 1961 issues; also Practical TV, August and September
1963.

**HIGH GRADE SWISS AND ENGLISH LEVER
WATCHES OVERHAULED, REPAIRED.** 12 months
guarantee. Estimates free. Difficult repairs a speciality.
Write for details and prices or send registered to:
B. Thornton, Watchmaker, Clay Hill, Beenham,
Reading, Berks.

BRAND NEW. 2N2147 16/- each. BC107 7/6d. each.
BC108 7/6d. each. BC109 7/6d. each. BFY51 8/6d.
BCY31 13/6d. 2N3819 25/- . ACY22 4/- . P.P. 6d.
C.W.O. mail only. Harvey, 29 The Drive, Potters
Bar, Herts.

Components for High Sensitivity V.H.F. Portable Receiver (See this and February issue).

Condensers—S.M. 4d. to 1/-; Ceramic 6d.; Poly. 9d. to 2/-;
Electr. 1/- to 4/-; German 2-gang tuner 15pF + 15pF with slow
motion tuning 7/6; AF114, 115, 116, AC127 all 7/- ea.; AF117 5/-;
OC44, 81, 81D 3/6 ea.; speaker 7" x 4" 12/6; aerial 7½" to 40" 7/6;
Cabinet and motif 15/-. All plus postage 6d. small packet to 3/6
cabinet. S.A.E. for full price list of above and free catalogue of
push-button stereogram chassis at £17.17.0. etc.

GLADSTONE RADIO

66 ELMS ROAD ALDERSHOT HAMPSHIRE
Telephone 22240 1 minute station and buses

NEW ELECTRONICS CATALOGUE

The convenient way to shop for all your
electronic needs. Everything from single
components to complete Hi-fi outfits, all at
highly competitive prices.

Send P.O. for 1/6 to:

Dept. RC/5

dca ELECTRONICS LIMITED
28 UXBRIDGE ROAD, EALING W.5

ELECTRONIC COMPONENTS

QUOTATIONS FOR COMPONENTS Send your list of require-
ments for competitive quotation by return of post. List of component
prices for all articles in this issue available on request.

A selection from our bargain lists of brand new components:—

HI-K DISC CERAMIC CAPACITORS 500V DC working. 1000pF2/6d.
per dozen, P.P. 9d. 0.01mfd. 3/9d. per dozen, P.P. 9d.

SUBMINIATURE ELECTROLYTICS 100mfd. 15V. at the fantastic
price of 9/6d. per dozen, P.P. 9d. or 5/6d. per ½-dozen, P.P. 9d.

RESISTOR PACKS 100 well assorted values and types, mainly ½w.
hy-stabs, but also some 1/10w., ¼w., 1W., 2W., 1% to 10%. A super buy
at 7/6d., P.P. 1/6d.

ROTARY WAFER SWITCH BARGAIN Parcel of 12 very useful
rotary switched (assorted) for only 7/6d., P.P. 2/-d. Worth at least £3.
Send 1/- in stamps for components catalogue and bargain lists.

BRIAN J. AYRES & CO.

Dept. FB, 8 Hartfield Road, Wimbledon, London, S.W.19.
Telephone 01-946 6063

PLAIN-BACKED NEW STYLE SELF-BINDERS

for your other magazines

(max. format 7½" × 9½")



The "CORDEX" Patent Self-Binding Case will keep your copies in mint condition. Issues can be inserted or removed with the greatest of ease. Rich maroon finish. Specially constructed Binding Cords are made from Super Linen of great strength, very hard twisted and twice doubled. They are attached to strong RUSTLESS Springs under tension, and the method adopted ensures PERMANENT RESILIENCE of the Cords. Any slack that may develop is immediately compensated for, and the Cords will always remain taut and strong. It is impossible to overstretch the springs, as a safety check-device is fitted to each.

PRICE **14'6** Post Free

Available only from:—

Data Publications Ltd.
57 Maida Vale London W9

CHASSIS and CASES by



H. L. SMITH & CO. LTD.
287/9 Edgware Road
London W2
TEL: 01-723 5891

BLANK CHASSIS—Same Day Service

Of over 20 different forms made up to YOUR SIZE.
(Maximum length 35", depth 4").

SEND FOR ILLUSTRATED LEAFLETS or order straight away, working out total area of material required (including waste) and referring to table below which is for four-sided chassis in 16 s.w.g. aluminium.

48 sq. in.	4/6	176 sq. in.	9/10	304 sq. in.	15/2
80 sq. in.	5/10	208 sq. in.	11/2	336 sq. in.	16/6
112 sq. in.	7/2	240 sq. in.	12/6	368 sq. in.	17/10
144 sq. in.	8/6	272 sq. in.	13/10	and pro rata	
	P. & P. 3/-		P. & P. 3/6		P. & P. 4/6

Discounts for quantities. More than 20 different sizes kept in stock for callers.

FLANGES (1/2" or 3/8"), 6d. per bend.
STRENGTHENED CORNERS, 1/- each corner.
PANELS
Any size up to 3ft at 6/- sq. ft. 16 s.w.g. (18 s.w.g. 5/3).
Plus postage and packing

CASES

ALUMINIUM, SILVER HAMMERED FINISH			Type W		
Type	Size	Price	Type	Size	Price
U	4 x 4 x 4"	10/-	W	15 x 9 x 8"	44/-
U	5 1/2 x 4 1/2 x 4 1/2"	15/6	Y	8 x 6 x 6"	26/6
U	8 x 6 x 6"	21/-	Y	12 x 7 x 7"	41/-
U	9 1/2 x 7 1/2 x 3 1/2"	22/-	Y	13 x 7 x 9"	46/-
U	15 x 9 x 9"	44/6	Y	15 x 9 x 7"	48/6
W	8 x 6 x 6"	21/-	Z	17 x 10 x 9"	66/-
W	12 x 7 x 7"	34/-	Z	19 x 10 x 8 1/2"	71/-

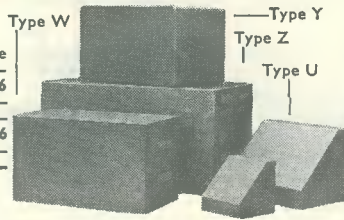

*Height
Type Z has removable back and front panels.
Type Y all-screwed construction.

BRASS · COPPER · LIGHT ALLOYS · ALUMINIUM BRONZE · STAINLESS STEEL

ROD, BAR, SHEET, TUBE, STRIP, WIRE. 3,000 STANDARD STOCK SIZES
No Quantity too small List on application

H. ROLLET & CO LTD

HOWIE ST. LONDON SW11 BATTERSEA 7872

Also at Liverpool, Birmingham, Manchester, Leeds, Glasgow

TREMENDOUS VALUE—Bulk Comp. Offers

- ★ ASSORTED RESISTORS—Hi-Stab. 300 off. (5%, 1/10 to 1/2 Watt, Worth £3.) 15/-
 - ★ TRANSISTORS—OC44, 45, 70, 71, 72, 81 & 82D Equivalents 3s.
 - ★ ASSORTED TRANSISTORS—6 Tested A.F. Devices 9/6.
- (P & P 1s. 6d. per order, C.W.O.)

Elmbridge Instruments Ltd. Island Farm Avenue
West Molesey Surrey

HAMMERITE HAMMER PATTERN BRUSH PAINT FOR PANELS, METALWORK, ETC.

3/6 TIN ● JUST BRUSH ON ● WITHSTANDS 150°C, OIL, WATER ETC.
COLOURS: blue, silver, black, or bronze.

2 1/2 oz tins, 3/6. 1/2 pint, 7/6. 1 pint, 15/-, 1/2 gallon, 35/- * 1 gallon 58/- *
Carr. up to 5/-, 9d., up to 10/-, 1/9, over 10/-, 3/- * Sent by road.

From component shops or direct from the manufacturer:
FINNIGAN SPECIALITY PAINTS (RC) Mickley Square, Stocksfield, Northumberland. Telephone: Stocksfield 2280

RESISTORS, CARBON FILM, LOW NOISE

1/4w., 10%, 2/- doz., 15/- 100. 1/2w. 5%, 2/3 doz., 17/3 100.
Values 4.7Ω to 10MΩ to your choice.

(No 5% intermediate values)
Many transistors in stock. Send for catalogue, 6d.
Examples: 2N1304/5, 4/3 each; BC108, 6/3 each.

ELECTROVALUE

6 MANSFIELD PLACE, ASCOT, BERKSHIRE

2N 2926 SERIES

This versatile silicon NPN transistor series is yet again . . .

DOWN IN PRICE

2N 2926 Red	(55—110)hf _e	Now 3/9 each.
2N 2926 Orange	(90—180)hf _e	Now 4/- each.
2N 2926 Yellow	(150—300)hf _e	Now 4/3 each.
2N 2926 Green	(235—470)hf _e	Now 4/6 each.

AND A 10% DISCOUNT (if bought in lots of 5 or more, per type).
Also available are hundreds of other semiconductors, including:

ACY 18, 5/-; ACY 20, 4/9; ACY 21, 5/3; ACY 22, 4/-; AF 139, 12/6;
BC 107, 8/-; NKT 211, 4/5; NKT 212, 4/3; NKT 217, 8/-; NKT 218, 3/11;
NKT 271, 3/4; NKT 274, 3/4; NKT 675, 4/3; NKT 676, 4/-; NKT 773, 4/8;
OC 170, 8/6; MAT 121, 8/6; 2G 302, 5/4; 2N 270, 9/9; 2N 384, 18/-;
2N 697, 9/9; 2N 706, 5/9; 2N 2147, 18/-; 2N 2646, 14/-; 2N 3638, 8/-.

Transistor price list (800/2) covering over 1500 items, will be sent on receipt of 2/- P.O. (inclusive of addition to mailing list).

MAIL ORDER ONLY PLEASE. TERMS: C.V.O. or C.O.D.

M. R. CLIFFORD & COMPANY (C5 K)

209A, Monument Road, Edgbaston, Birmingham, 16.
Please add 2/- Postage & Packing on all orders of £1 or less.

BUILD YOUR CIRCUITS

on

VEROBOARD

—the Universal Wiring Board—
obtainable from your local retailer

Trade enquiries to:—

NORMAN ROSE (ELECTRICAL) LTD
8 St. Chad's Place, Grays inn Road, London, W.C.1

Technical enquiries to:—

VERO ELECTRONICS
Chandler's Ford, Hampshire

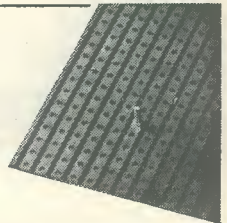

THE RADIO CONSTRUCTOR ANNUAL SUBSCRIPTIONS to this magazine may be obtained direct from the publishers ONLY 36/- per year, post free

Please send remittance with name and address and commencing issue required to:

DATA PUBLICATIONS LTD 57 MAIDA VALE LONDON W9

Please mention **THE RADIO CONSTRUCTOR** when writing to advertisers

DATA BOOKS SERIES

NEW REVISED AND ENLARGED EDITION

DB5 TV Fault Finding

124 pages. Price 8/6, postage 8d.

Profusely illustrated with photographs taken from a television screen depicting the faults under discussion and containing a wealth of technical information, with circuits, enabling those faults to be eradicated.

Now includes B.B.C.II as well as B.B.C.I and I.T.A.

"... A book that should be in every television dealer's service workshop, and in every home-constructor's, for that matter."—*Journal of the Television Society*.

DB6 The Radio Amateur Operator's Handbook

64 pages. Price 5/—, postage 5d.

Contains Amateur Prefixes, Radio Zone Boundaries, Amateur Band Frequency Allocations, Call Areas, Charts and Maps, Areas, Codes, Mileage Tables, Prefixes/Directional Bearings, Post Office Regulations, and much other useful operating data. For the beginner there are notes on how to use the mass of information given to obtain the greatest satisfaction from the hobby.

"... For concise knowledge in this field a few shillings well worth spending."—*Electronics (Australia)*.

DB14 Short Wave Receivers for the Beginner

72 pages. Price 6/—, postage 6d.

Contains a selection of both battery and mains operated short wave receivers, circuits, point-to-point wiring diagrams and many illustrations. Introductory chapter gives much information on the Short Wave Spectrum, Clubs, QSL'ing, Aerials, Amateur and Broadcast Band Listening, Frequencies, etc. This book has been specially prepared for the beginner interested in short wave receiver construction and operation.

DB15 Twenty Suggested Circuits

48 pages. Price 3/6, postage 5d.

By G. A. French. Covers subjects ranging from electronic laboratory equipment to the simplest of periodic switches. Includes: simple and inexpensive two-valve capacity bridge, short wave regeneration preselector, one-valve speech operated switching circuit, transformer ratio analyser, series noise limiter, receiver remote mains on-off control, and many other circuits.

DB16 Radio Control for Models

192 pages. Price 15/—, postage 9d.

By F. C. Judd. Contains both theory and practical designs of simple and advanced transmitters and receivers; basic concepts, aerials, uses of radio components, transistorised receivers, multi-channel operation, etc. Sections on servo-mechanisms by Raymond F. Stock. More than 200 illustrations. Circuits, photographs, tables and working diagrams.

DB17 Understanding Television

512 pages. Price 37/6, postage 3/—.

By J. R. Davies. This book, which deals with the principles of 625 line reception as fully as 405 line reception, fully explains: the nature of the television signal; the cathode ray tube; receiver tuner units; receiver i.f. amplifiers; a.f. and video amplifiers; vertical and horizontal timebases; deflector coil assemblies; synchronising; automatic gain and contrast control; power supplies and receiver aerials. Also includes a comprehensive introduction to colour television.

"... one of the best books that aims to explain television in simple language. . . ." R.S.G.B. Bulletin.

I enclose Postal Order/Cheque for..... in payment for.....

NAME

ADDRESS

(Please use Block Capitals for both name and address)

Postal Orders should be crossed and made payable to Data Publications Ltd.

Overseas customers please pay by International Money Order

All publications are obtainable from your local bookseller

Data Publications Ltd., 57 Maida Vale, London W.9



MAYFAIR PORTABLE ELECTRONIC ORGAN

Build the World's first All-Transistor Portable Electronic Organ Kit

- Plug-in printed circuit ● 170 transistors and devices ● 10 selected tone colours ● Fully sprung keyboard ● Vibrato ● 6 Octaves of generators ● Simple locked-in tuning ● 110/250 volt mains unit ● Cabinet size 30½" x 15½" x 9" ● Weight 35 lb. Cabinet with detachable legs, music stand and foot swell pedal ● Fully detailed building manual with photos, drawings and full circuits. All parts sold separately.



COMPLETE RANGE OF ELECTRONIC ORGAN COMPONENTS IN STOCK

CALL IN FOR DEMONSTRATION

★ COMPLETE KIT with Cabinet and Handbook **99 GNS.**

(Carriage and Packing 30/- extra)

★ Detailed leaflet on request

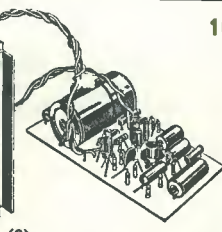
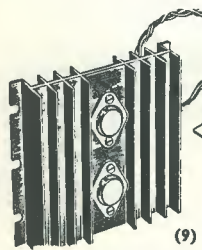

10 & 20 W Mono & Stereo Transistor Amplifiers

(9) **POWER AMPLIFIERS.** 10 watts RMS output, 100mV input. 30 c/s to 20 kc/s ± 1dB. 6-Transistor Push-pull. Panel size 4" x 2½" x 1", H/S 4" x 4".
 TPA10/3 3-5Ω spkr. £4.10.0, p.p. 2/6
 TPA10/15 12-16Ω spkr., £5.5.0, p.p. 2/6
 (Mains unit for 1 or 2 amplifiers, 59/6, p.p. 2/6)

(10) **PREAMPLIFIERS.** 8 input selector. Treble, bass, volume, filter controls. 1½mV to 300mV inputs. Battery operated or from Mains Unit. Output up to 150mV RMS.
 MP2 9½" x 2½" x 2". £5.10.0, p.p. 2/6 (grey and gold front panel 8/6)
 SP4 Mono/Stereo, 9" x 3½" x 1½", £10.19.6, p.p. 3/6 (front panel plate 12/6).

The finest High Fidelity at Unbeatable Prices

ALL UNITS BUILT AND TESTED

(1) **REGENT-6 MW/LW Pocket Radio to Build**
 6-Transistor superhet. Gearing tuning. Push-pull speaker output. Moulded cabinet 5 x 3 x 1½in. Phone socket.
TOTAL COST 69/6
TO BUILD P.P. 2/-
 Full tuning on both bands.

TUNNEL DIODES
 1mA 22/6; 5mA 15/-; 15mA 12/6. Brand new at fraction of normal price. Free Specs. supplied.

DETAILED BOOKLET FREE ON REQUEST

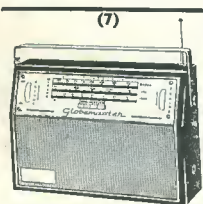

(7)

(2) **MW/LW QUALITY TRANSISTOR RADIO TUNER**
 Fully tunable superhet with excellent sensitivity and selectivity. Output up to ½ volt peak. Complete with front panel, etc. 9 volt operated. For use with any amplifier or tape recorder.
TOTAL COST P.P. 2/6
TO BUILD £3.19.6

25 watt transistor amplifier £7.19.6, p.p. 3/- (mains unit, 79/6, p.p. 3/-).

(3) **5 WATT AMPLIFIER**
 6-Transistor Push-pull, 3 ohms. 6mV into 1K. 12/18V supply, 2½" x 2 x 1½in.
BUILT AND TESTED P.P. 2/-
 (optional mains units 54/-) **69/6**
 1½ watt version 59/6.
 Matching Preamplifier, 6 inputs, treble/bass/selector/volume controls. 6-10mV o/p. 9-18V supply. 79/6, p.p. 2/-.
 For use with only Transistor Amplifier

(11) **GARRARD BATTERY 2-SPEED TAPE DECK**
 Brand New with R/P head, erase/osc. head, tape cassette. Specifications and osc. circuits. 2 speed 2-track 9 volt operated. List Price 13 gns.
PRICE £8.19.6 P.P. 3/6

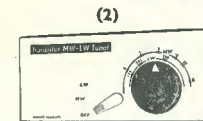

(2)

(4) **BUILD A QUALITY 2 OR 4 TRACK TAPE RECORDER**
 3-speed version using new '363' decks.
 ● **TWO-TRACK.** Deck £10.10.0. Martin Amplifier £14.19.6. Cabinet and speaker 7 gns. Complete kits with FREE 7in. 1200ft. tape, spare spool. P.P. 15/-
 Today's Value £45 **27 gns.**

(5) **VHF FM TUNER TO BUILD**
 Gearing tuning. Terrific quality and sensitivity. For valve or transistor amplifiers. 4 x 3½ x 2½in. Complete with dial plate. (FM Decoder Kit £5.19.6, p.p. 2/-).
TOTAL COST £6.19.6 P.P. 2/6
 (Cabinet Assembly 20/- extra)



(8)

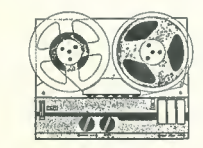

(4)

(6) **GARRARD DECKS—BRAND NEW FULLY GUARANTEED**

1000 mono	£5 19 6	SP25 stereo	£10 19 6	40lesscart./arm	£27 10 0
1000 stereo	£6 6 0	SP25 Deram	£13 19 6	AT6 mono	£8 19 6
2000 mono	£6 9 6	AT60 less cart	£10 19 6	AT6 stereo	£9 10 0
2000 stereo	£6 19 6	AT60 mono	£11 10 0	AT6 Deram	£11 19 0
3000lm stereo	£7 19 6	AT60 stereo	£11 19 6	Decadec Mk.II	£17 17 6
SP25 less cart.	£9 19 6	AT60 Deram	£14 19 6	A70 less cart.	£17 17 0
SP25 mono	£10 10 0	LAB80 less cart.	£25 0 0	(P. & P. 5/- any type)	

All other makes of decks and cartridge in stock



(3)



(1)

(7) **GLOBEMASTER MW/LW/SW PORTABLE RADIO TO BUILD**
 Full 3-waveband tuning. Pushbutton wavechange. 6-transistor. Superhet printed circuit. Blackchromed cabinet 11 x 7½ x 3½in. (SV 17-50m). Ear/Record sockets. 1 watt Push/Full o/p.
TOTAL COST P.P. 2/6
TO BUILD £7.19.6

(8) **TOURMASTER CAR RADIO**
 7-Transistor MW/LW Car Radio. 12 volt operated. 3 watt output. Push-button wave-change. RF stage. Supplied built, boxed, ready to use with Speaker and Baffle. Car fixing kit and manufacturers' current guarantee. Special Bargain Offer. Buy Now! List Price 13 gns.
PRICE £9.9.0 P.P. 3/6

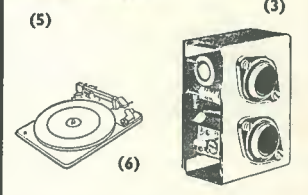

(6)

STABILISED POWER SUPPLY
 Two outputs, 3.6 volts and 9.6 volt up to 250mA each. Transistorised and Tuner stabilised. 110 to 250 volt mains input. In case with leads. Price 67/6, p.p. 2/6.

MARRIOT TAPE HEADS
 ½ Track R/RP/3 Med. z. 7/6. R/RP/1 High z. 8/-. R/RP/1 High z. + R/E/1 erase on block, 19/6. ½ Track L/RPS/12 High z. 15/-. L/RPS/7 Med. z. 19/6. 5/ES/9 erase, 12/6. Also HR-RP single track Rec/Play Med. z. 6/6.

FM STEREO DECODER
 7-Transistor Printed Circuit Design with Stereo Indicator. For use with any valve or transistor FM. Uses pot cores to Mullard design and ger. and silicon transistors. Complete P.P. 2/-
Kit Price £5.19.6

SCR's (Thyristors)
 50 PIV 7/6. 100 PIV 7/6. 200 PIV 12/6. 300 PIV 15/-. 400 PIV (280V Rms) 17/6. 100 PIV, 3 Amp Stud Type 9/6. 400 PIV, 7 Amp (280V Rms) Stud Type 25/-.

HENRY'S RADIO LTD.
 303 Edgware Road, London, W.2
 PAddington 1008/9 (STD 01-723-1008)
 Open Mon. to Sat. 9-6. Thurs. 1 p.m.

1967 CATALOGUE
 Have you a copy? Fully detailed and illustrated. Over 200 pages of components, equipment, etc. Over 5,000 stock items. PRICE 8/6, post paid. Free discount vouchers, value 10/-, with every catalogue.

We can supply from stock most of the components specified on circuits in this magazine. Send for quotation.

NEW 24 PAGE TRANSISTOR CATALOGUE 1/-